

# 1

## Primary Elements

“All pictorial form begins with the point that sets itself in motion . . . The point moves . . . and the line comes into being—the first dimension. If the line shifts to form a plane, we obtain a two-dimensional element. In the movement from plane to spaces, the clash of planes gives rise to body (three-dimensional) . . . A summary of the kinetic energies which move the point into a line, the line into a plane, and the plane into a spatial dimension.”

Paul Klee

*The Thinking Eye: The Notebooks of Paul Klee*

(English translation)

1961

## PRIMARY ELEMENTS

This opening chapter presents the primary elements of form in the order of their growth from the point to a one-dimensional line, from the line to a two-dimensional plane, and from the plane to a three-dimensional volume. Each element is first considered as a conceptual element, then as a visual element in the vocabulary of architectural design.

As conceptual elements, the point, line, plane, and volume are not visible except to the mind's eye. While they do not actually exist, we nevertheless feel their presence. We can sense a point at the meeting of two lines, a line marking the contour of a plane, a plane enclosing a volume, and the volume of an object that occupies space.

When made visible to the eye on paper or in three-dimensional space, these elements become form with characteristics of substance, shape, size, color, and texture. As we experience these forms in our environment, we should be able to perceive in their structure the existence of the primary elements of point, line, plane, and volume.

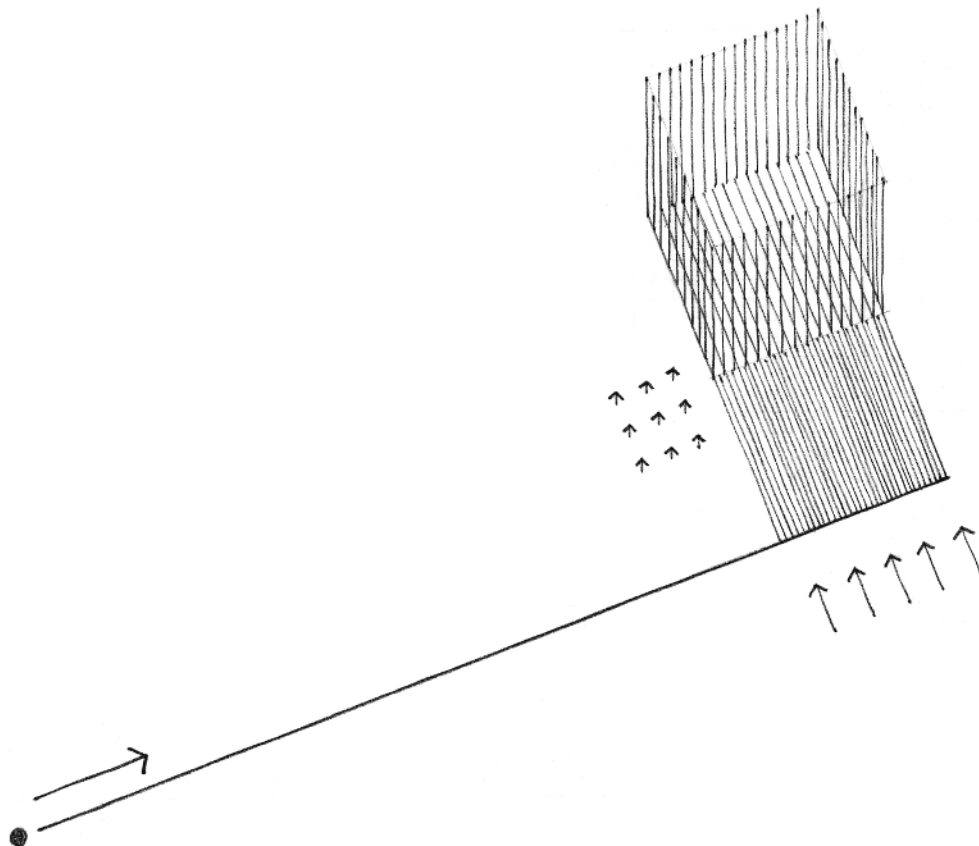

As the prime generator of form, the

**Point** indicates a position in space. •

**Line** A point extended becomes a line with properties of:

- Length
- Direction
- Position



**Plane** A line extended becomes a plane with properties of:

- Length and width
- Shape
- Surface
- Orientation
- Position

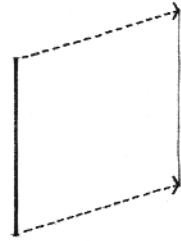

**Volume** A plane extended becomes a volume with properties of:

- Length, width, and depth
- Form and space
- Surface
- Orientation
- Position

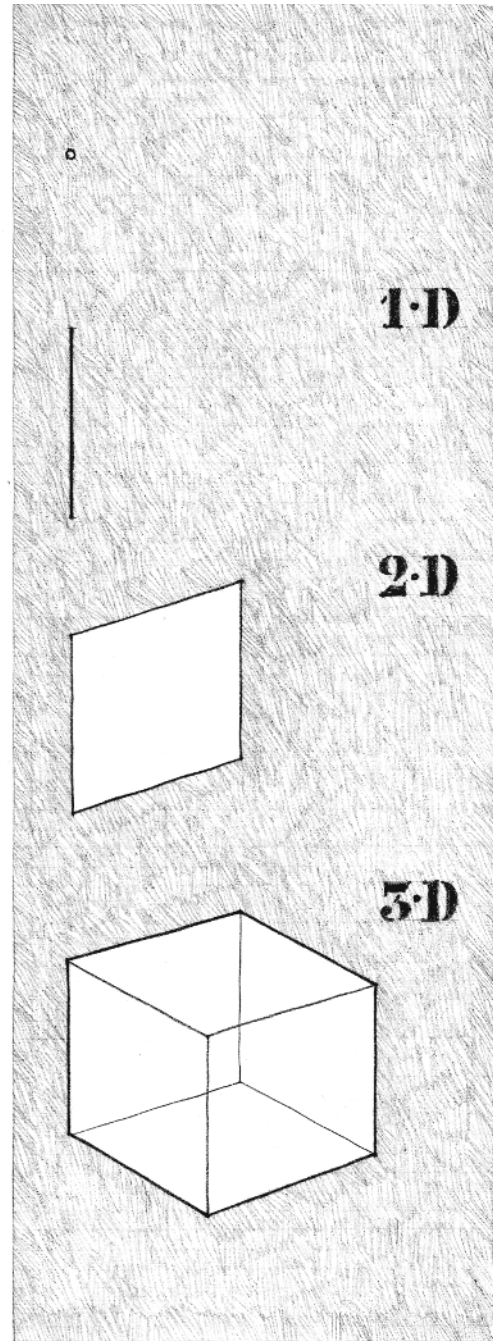
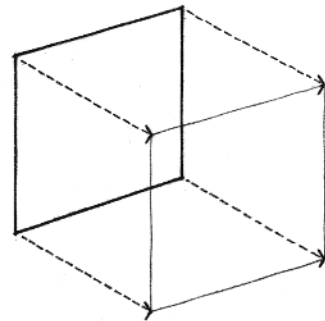

Point

Line

Plane

Volume

# POINT

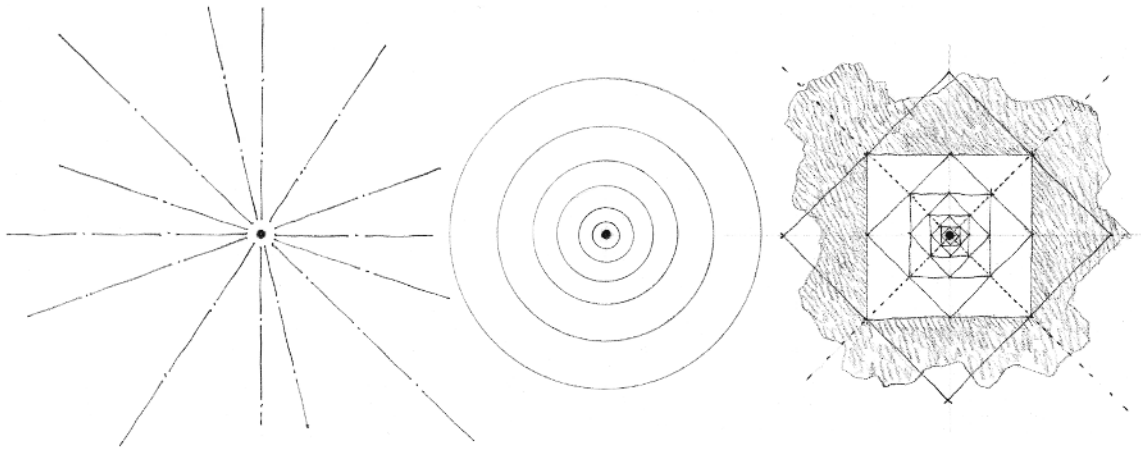

A point marks a position in space. Conceptually, it has no length, width, or depth, and is therefore static, centralized, and directionless.

As the prime element in the vocabulary of form, a point can serve to mark:

- The two ends of a line
- The intersection of two lines
- The meeting of lines at the corner of a plane or volume
- The center of a field

Although a point theoretically has neither shape nor form, it begins to make its presence felt when placed within a visual field. At the center of its environment, a point is stable and at rest, organizing surrounding elements about itself and dominating its field.

When the point is moved off-center, however, its field becomes more aggressive and begins to compete for visual supremacy. Visual tension is created between the point and its field.

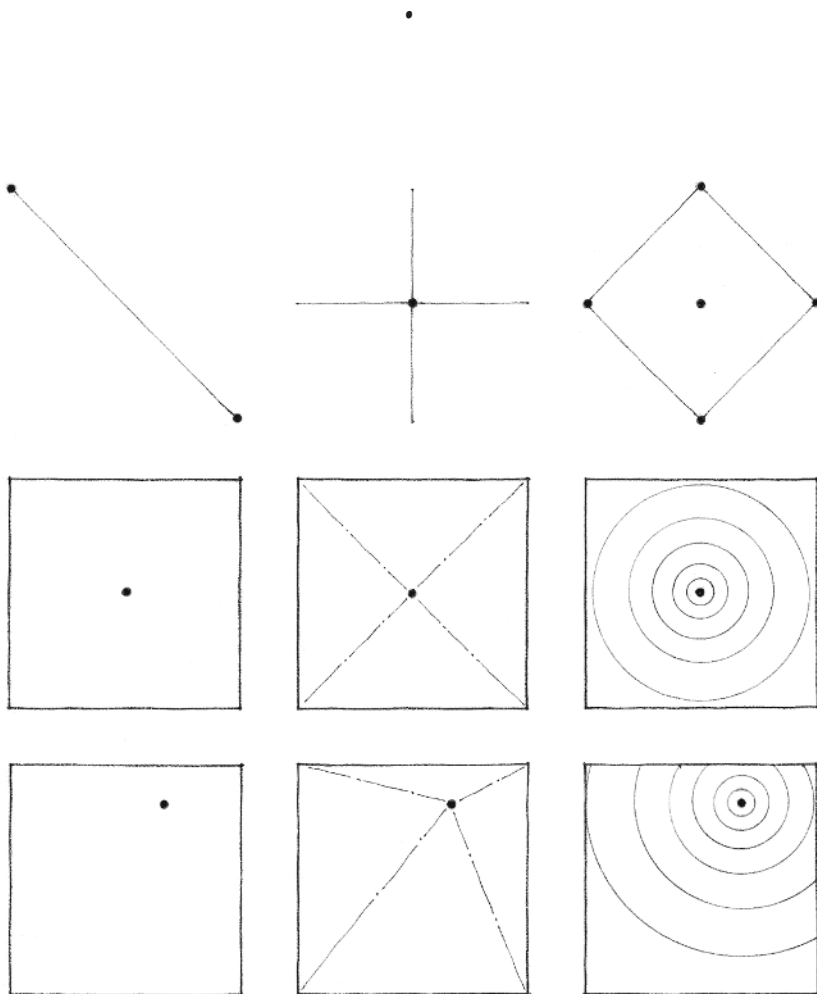

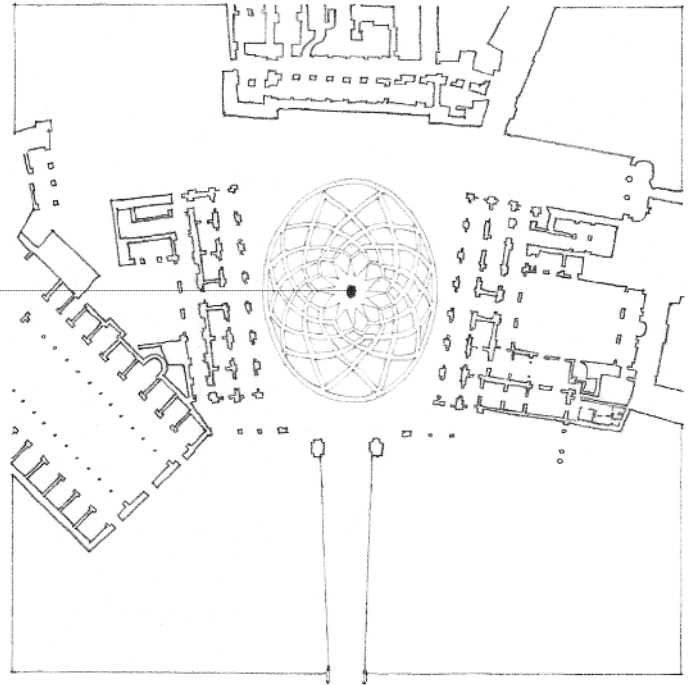
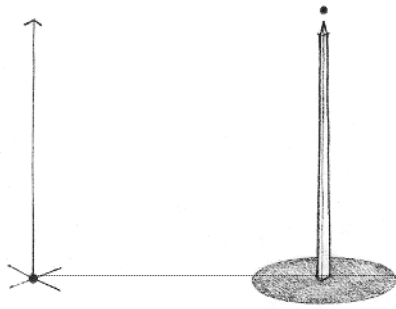

A point has no dimension. To visibly mark a position in space or on the ground plane, a point must be projected vertically into a linear form, as a column, obelisk, or tower. Any such columnar element is seen in plan as a point and therefore retains the visual characteristics of a point. Other point-generated forms that share these same visual attributes are the:

**Piazza del Campidoglio**, Rome, c. 1544, Michelangelo Buonarroti.  
The equestrian statue of Marcus Aurelius marks the center of this urban space.

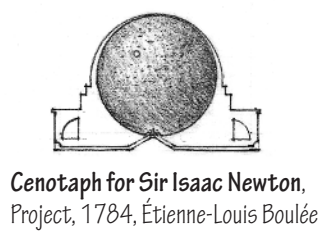
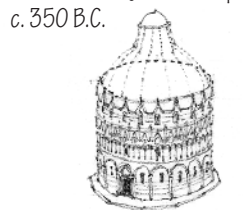
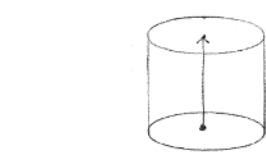
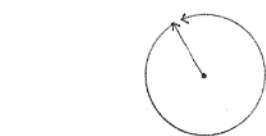

**Mont St. Michel**, France, 13th century and later.  
The pyramidal composition culminates in a spire that serves to establish this fortified monastery as a specific place in the landscape.

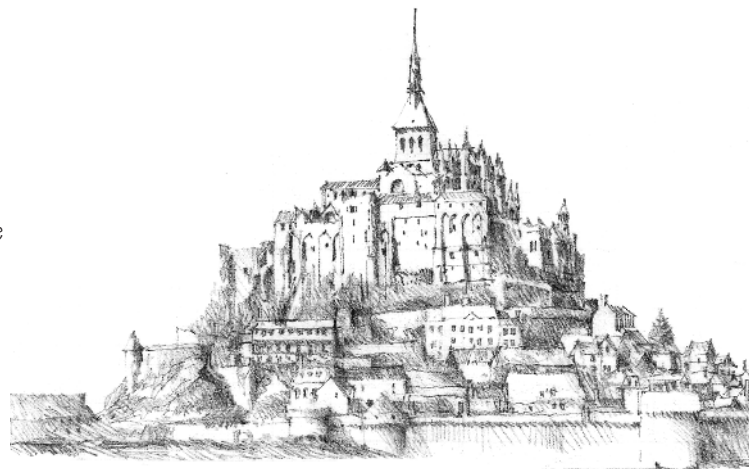

## TWO POINTS

Two points describe a line that connects them. Although the points give this line finite length, the line can also be considered a segment of an infinitely longer path.

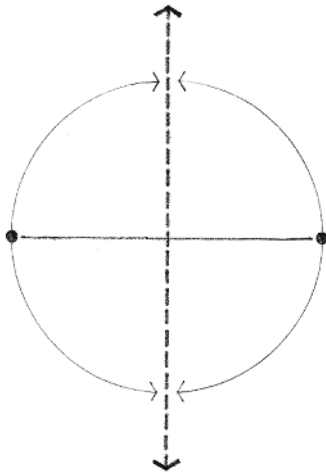

Two points further suggest an axis perpendicular to the line they describe and about which they are symmetrical. Because this axis may be infinite in length, it can be at times more dominant than the described line.

In both cases, however, the described line and the perpendicular axis are optically more dominant than the infinite number of lines that may pass through each of the individual points.

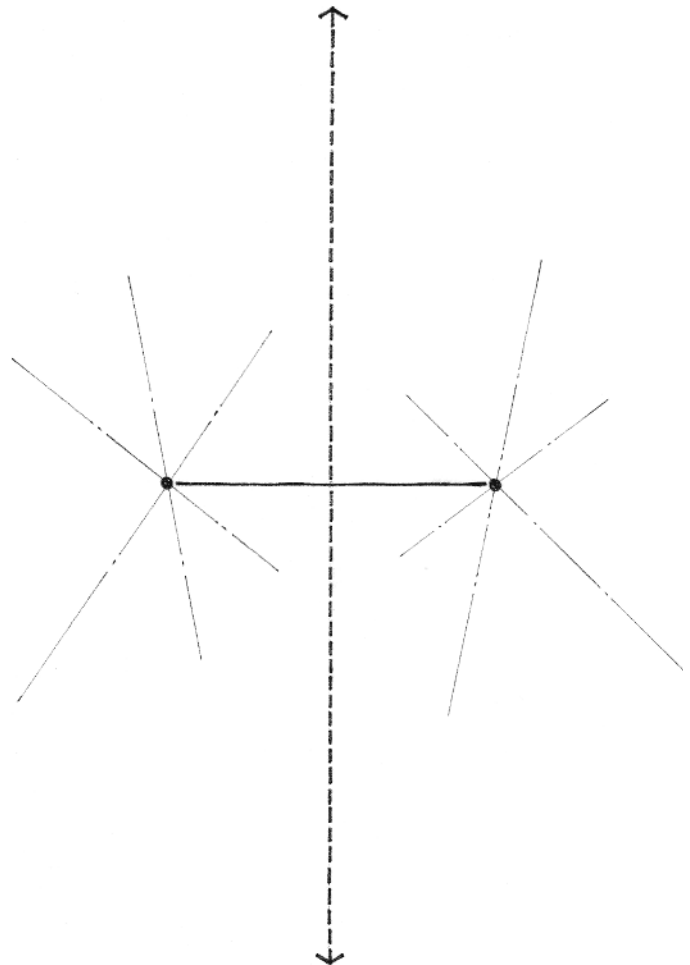

Two points established in space by columnar elements or centralized forms can define an axis, an ordering device used throughout history to organize building forms and spaces.

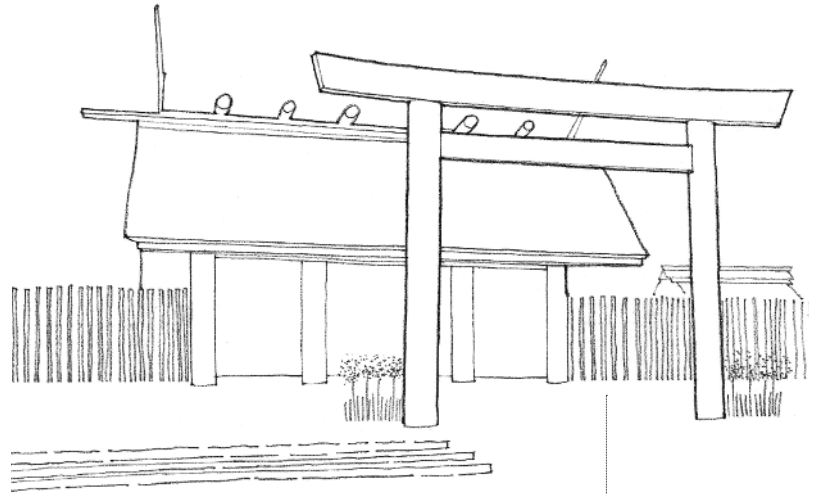

**Torii, Ise Shrine**, Mie Prefecture, Japan, A.D. 690

In plan, two points can denote a gateway signifying passage from one place to another. Extended vertically, the two points define both a plane of entry and an approach perpendicular to it.

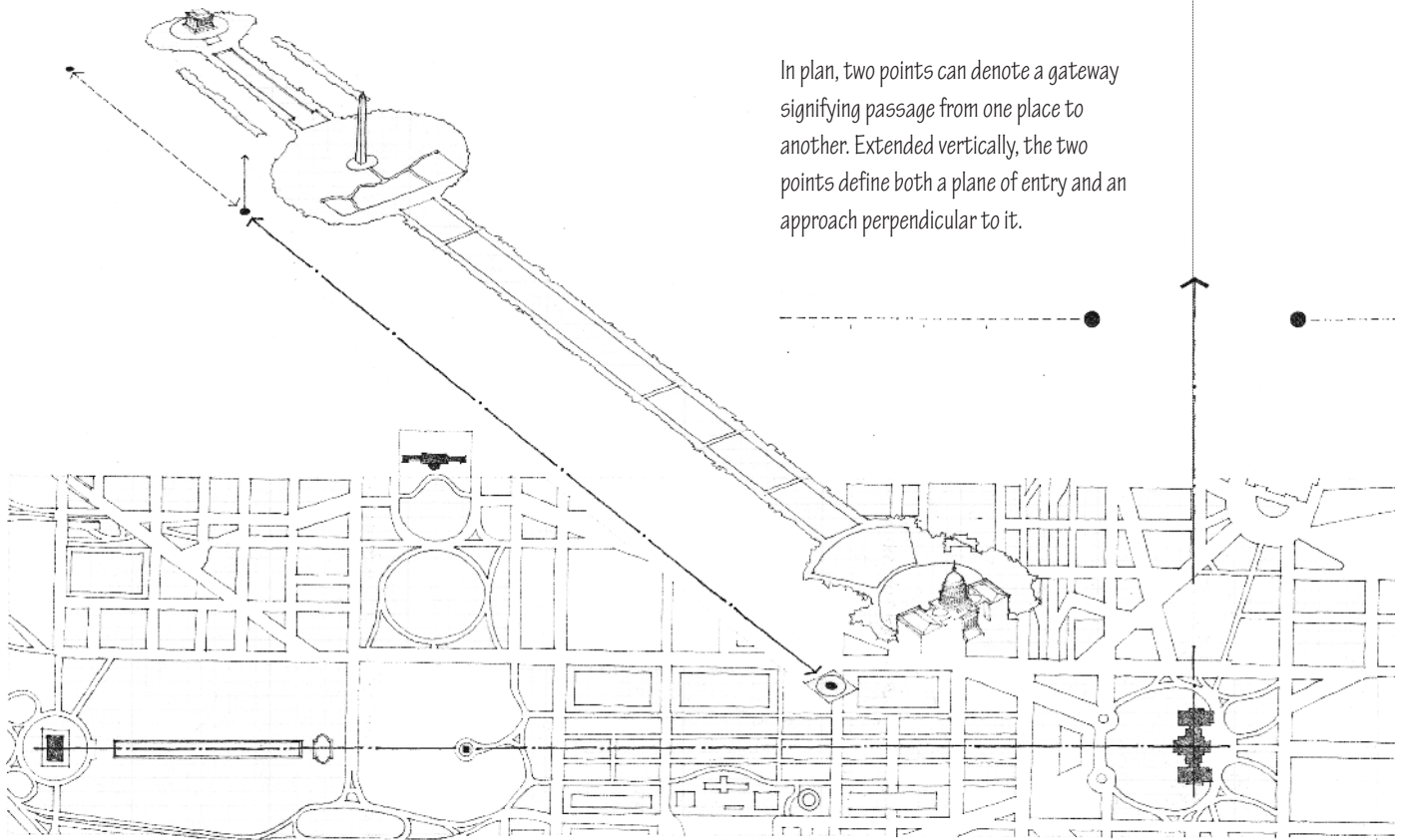

**The Mall, Washington, D.C.**, lies along the axis established by the Lincoln Memorial, the Washington Monument, and the United States Capitol building.

# LINE

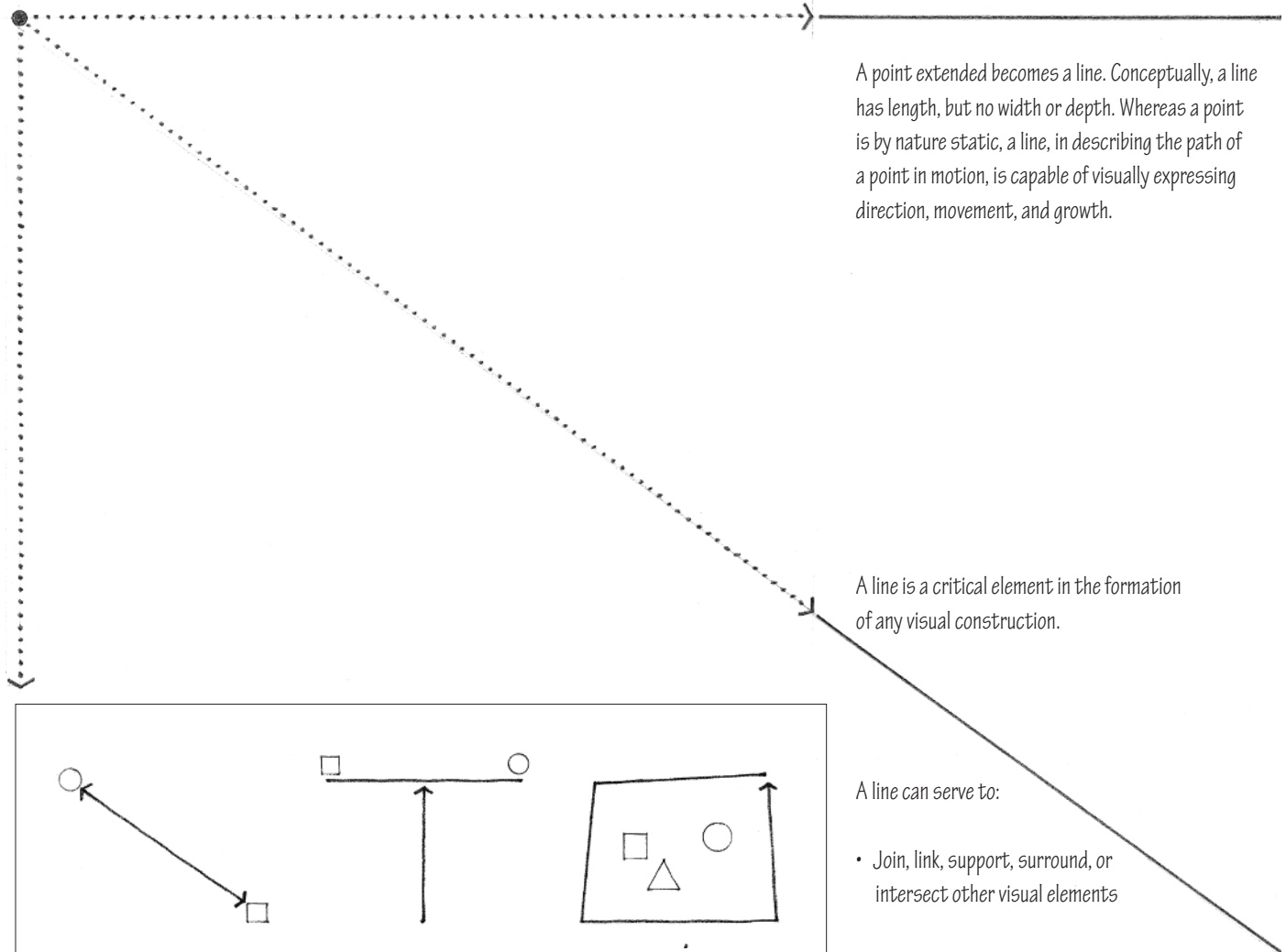

A point extended becomes a line. Conceptually, a line has length, but no width or depth. Whereas a point is by nature static, a line, in describing the path of a point in motion, is capable of visually expressing direction, movement, and growth.

A line is a critical element in the formation of any visual construction.

A line can serve to:

- Join, link, support, surround, or intersect other visual elements
- Describe the edges of and give shape to planes
- Articulate the surfaces of planes

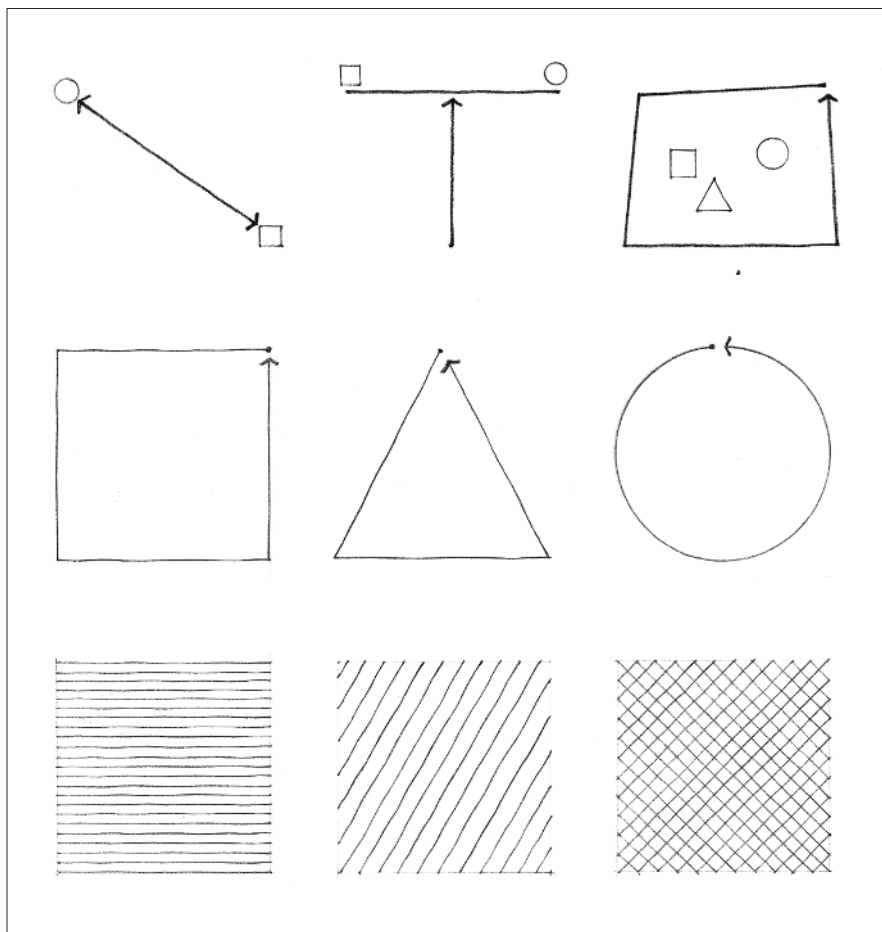

Although a line theoretically has only one dimension, it must have some degree of thickness to become visible. It is seen as a line simply because its length dominates its width. The character of a line, whether taut or limp, bold or tentative, graceful or ragged, is determined by our perception of its length-width ratio, its contour, and its degree of continuity.



Even the simple repetition of like or similar elements, if continuous enough, can be regarded as a line. This type of line has significant textural qualities.



The orientation of a line affects its role in a visual construction. While a vertical line can express a state of equilibrium with the force of gravity, symbolize the human condition, or mark a position in space, a horizontal line can represent stability, the ground plane, the horizon, or a body at rest.

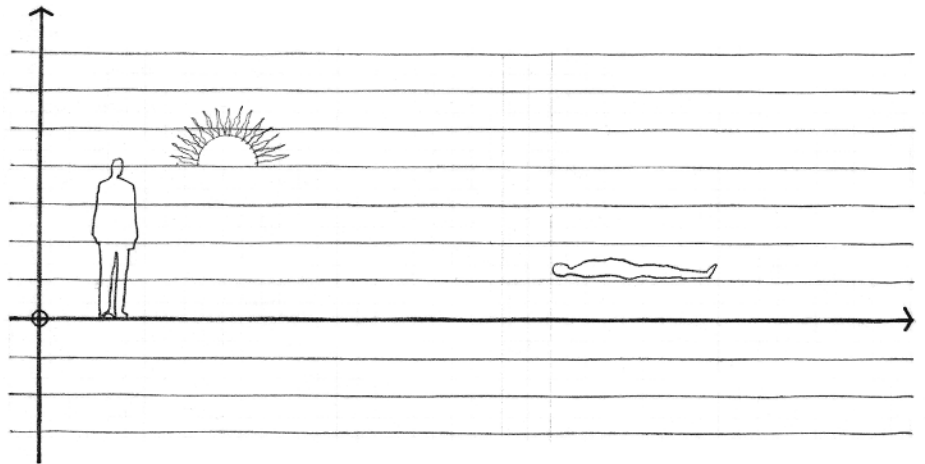

An oblique line is a deviation from the vertical or horizontal.

It may be seen as a vertical line falling or a horizontal line rising. In either case, whether it is falling toward a point on the ground plane or rising to a place in the sky, it is dynamic and visually active in its unbalanced state.

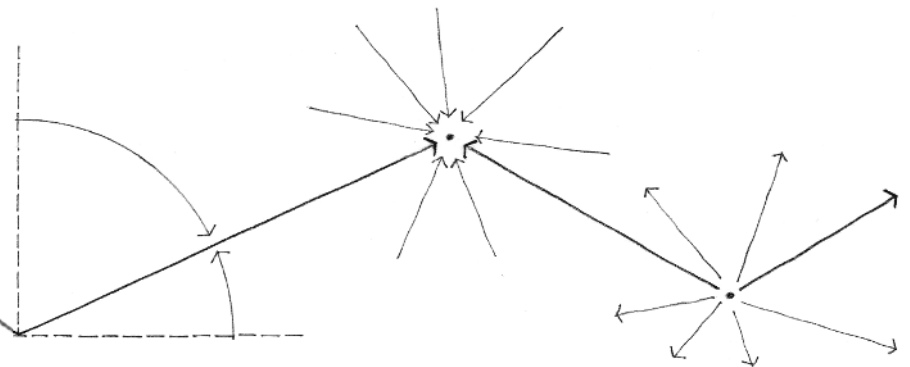

## LINEAR ELEMENTS

Vertical linear elements, such as columns, obelisks, and towers, have been used throughout history to commemorate significant events and establish particular points in space.

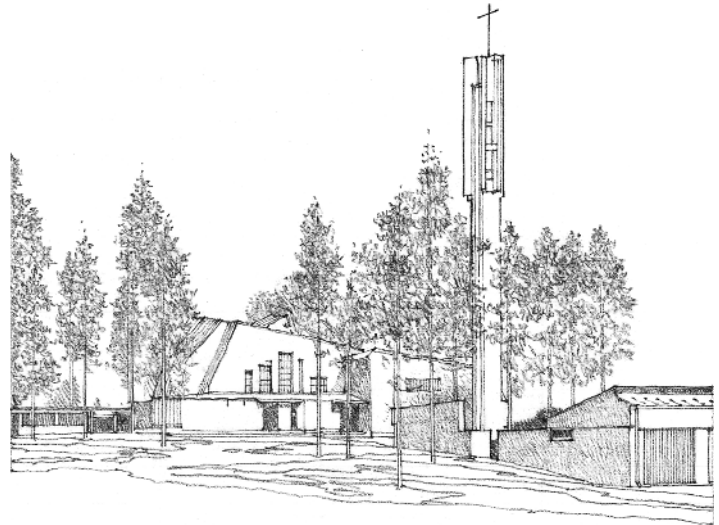

**Bell Tower, Church at Vuoksenniska,**  
Imatra, Finland, 1956, Alvar Aalto

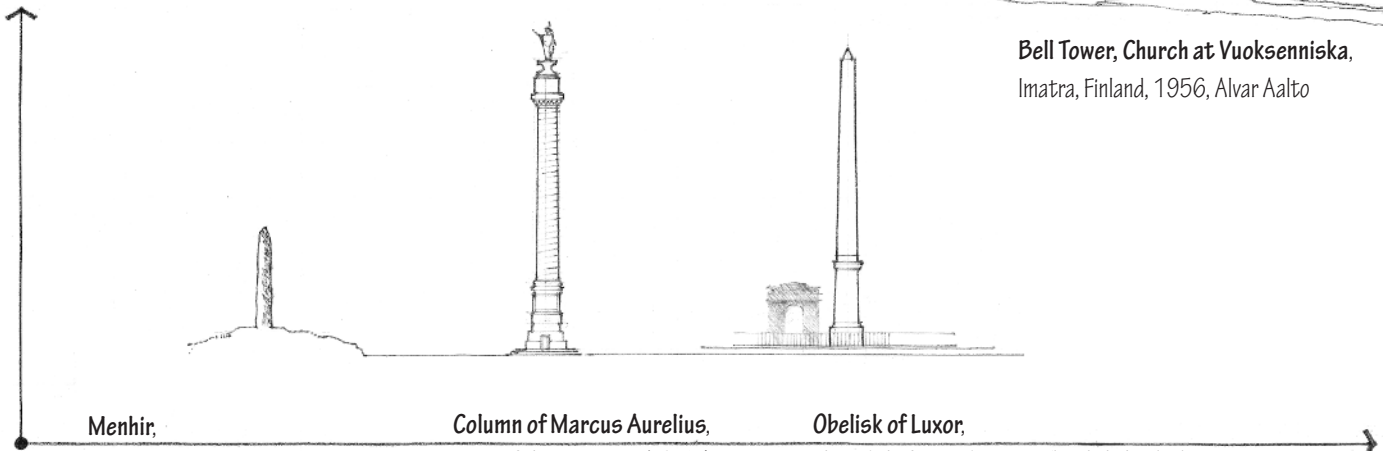

**Menhir,**

a prehistoric monument consisting of an upright megalith, usually standing alone but sometimes aligned with others.

**Column of Marcus Aurelius,**

Piazza Colonna, Rome, A.D. 174. This cylindrical shaft commemorates the emperor's victory over Germanic tribes north of the Danube.

**Obelisk of Luxor,**

Place de la Concorde, Paris. The obelisk, which marked the entrance to the Amon Temple at Luxor, was given by the viceroy of Egypt, Mohamed Ali, to Louis Phillipe and was installed in 1836.

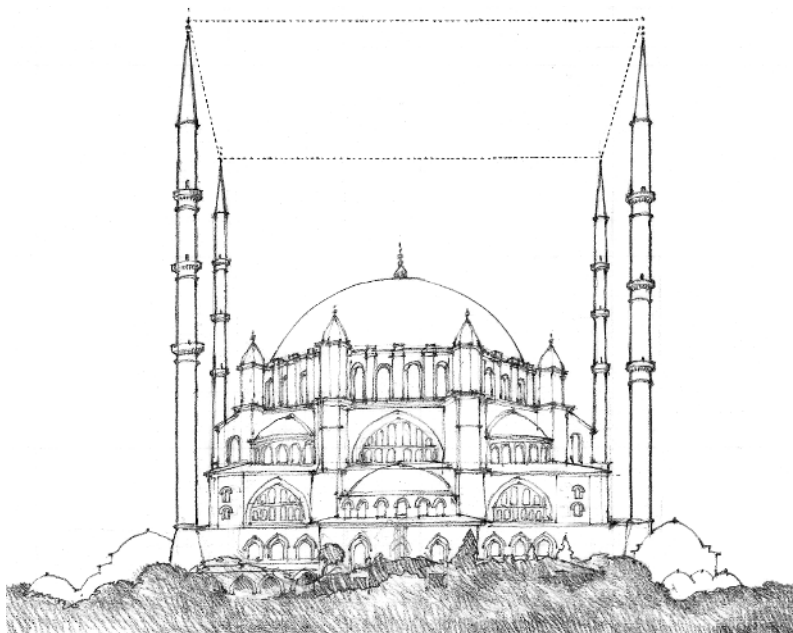

Vertical linear elements can also define a transparent volume of space. In the example illustrated to the left, four minaret towers outline a spatial field from which the dome of the Selim Mosque rises in splendor.

**Selim Mosque,** Edirne, Turkey, 1569–1575,  
Mimar Sinan

Linear members that possess the necessary material strength can perform structural functions. In these three examples, linear elements:

- Express movement across space
- Provide support for an overhead plane
- Form a three-dimensional structural frame for architectural space

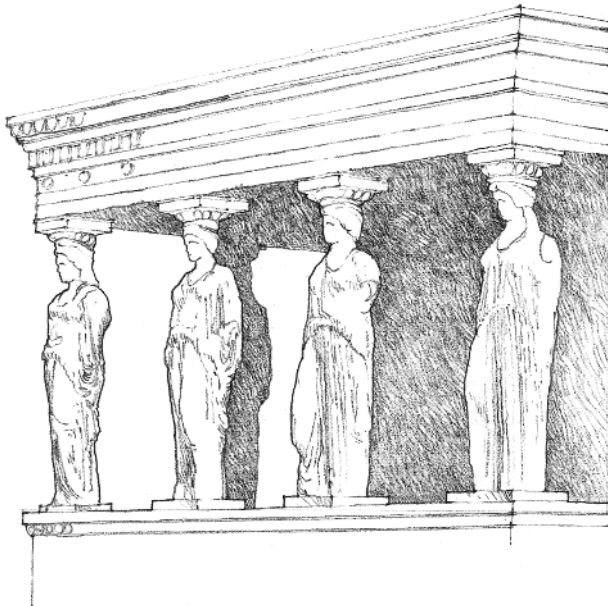
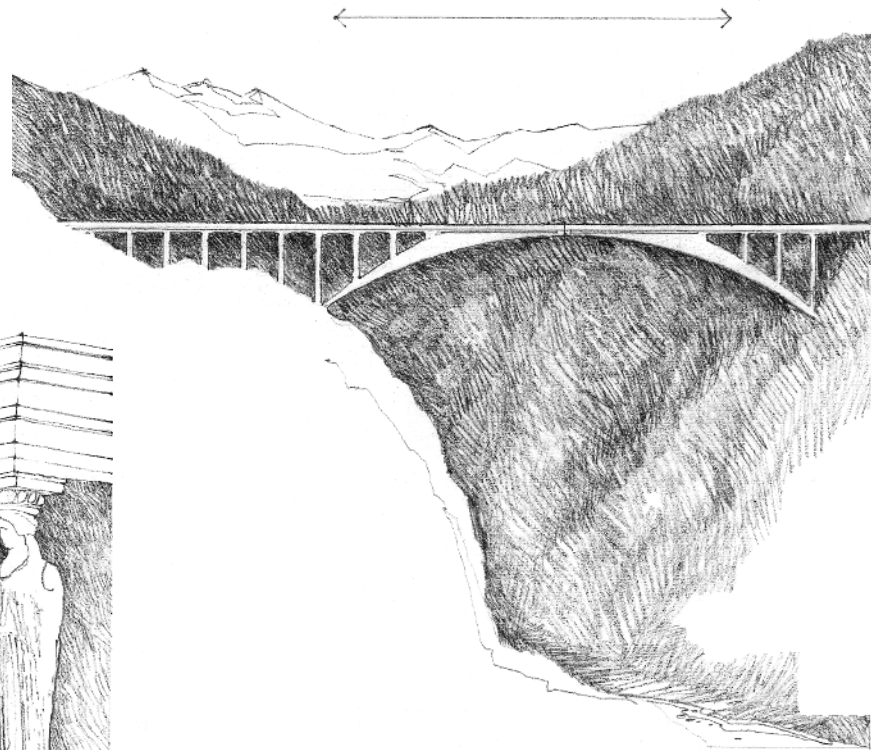

**Caryatid Porch**, The Erechtheion, Athens, 421–405 B.C., Mnesicles.  
The sculptured female figures stand as columnar supports for the entablature.

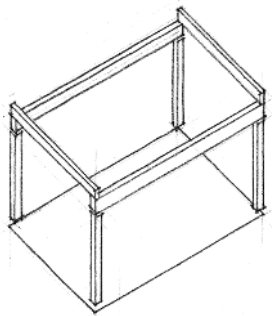
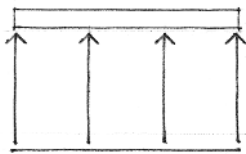

**Salginatobel Bridge**, Switzerland, 1929–1930, Robert Maillart.  
Beams and girders have the bending strength to span the space between their supports and carry transverse loads.

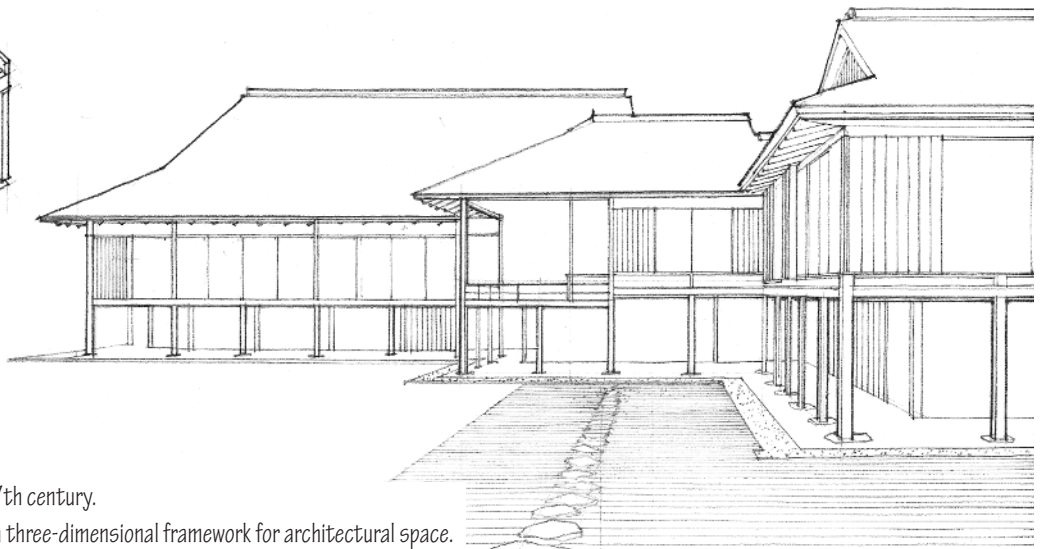

**Katsura Imperial Villa**, Kyoto, Japan, 17th century.  
Linear columns and beams together form a three-dimensional framework for architectural space.

## LINEAR ELEMENTS

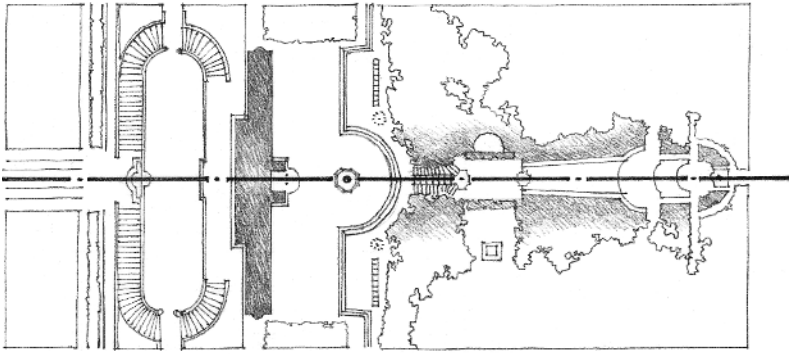

A line can be an imagined element rather than a visible one in architecture. An example is the axis, a regulating line established by two distant points in space and about which elements are symmetrically arranged.

Villa Aldobrandini, Italy, 1598–1603, Giacomo Della Porta

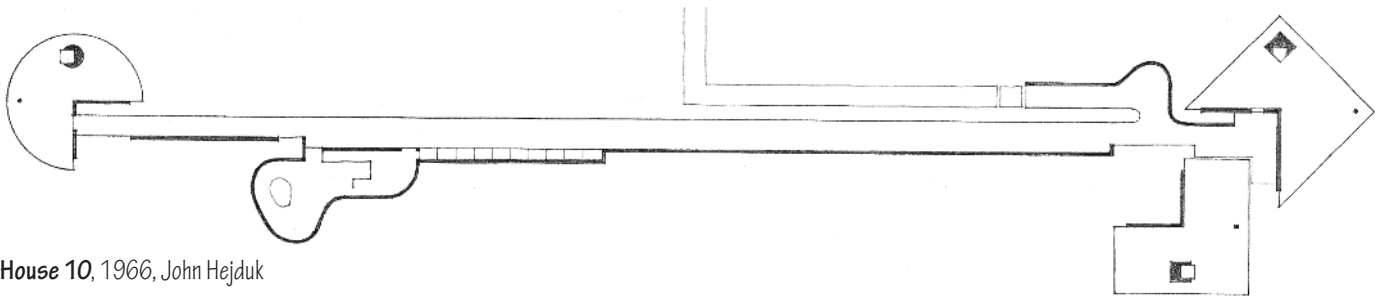

House 10, 1966, John Hejduk

Although architectural space exists in three dimensions, it can be linear in form to accommodate the path of movement through a building and link its spaces to one another.

Buildings also can be linear in form, particularly when they consist of repetitive spaces organized along a circulation path. As illustrated here, linear building forms have the ability to enclose exterior spaces as well as adapt to the environmental conditions of a site.

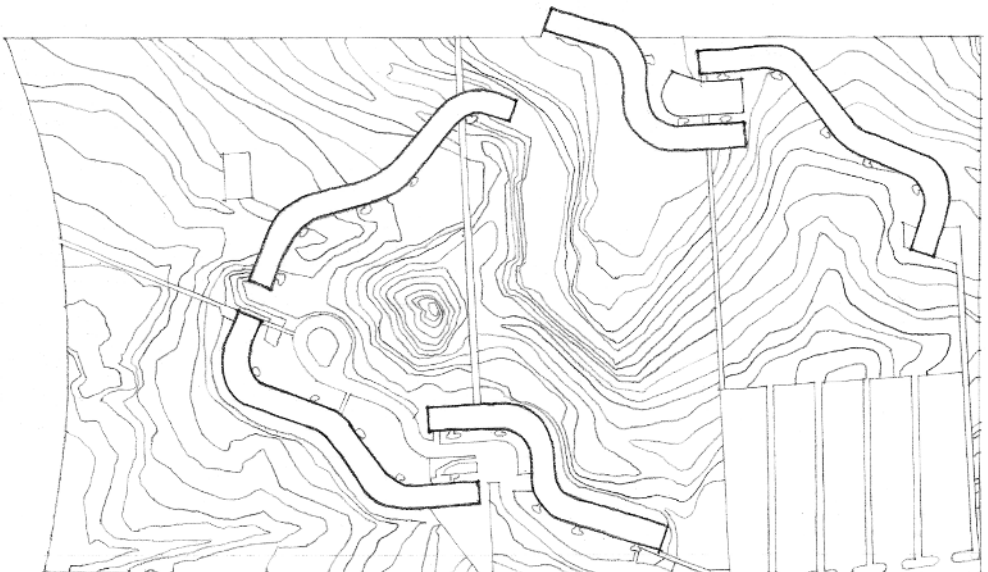

Cornell University Undergraduate Housing (Project), Ithaca, New York, 1974, Richard Meier

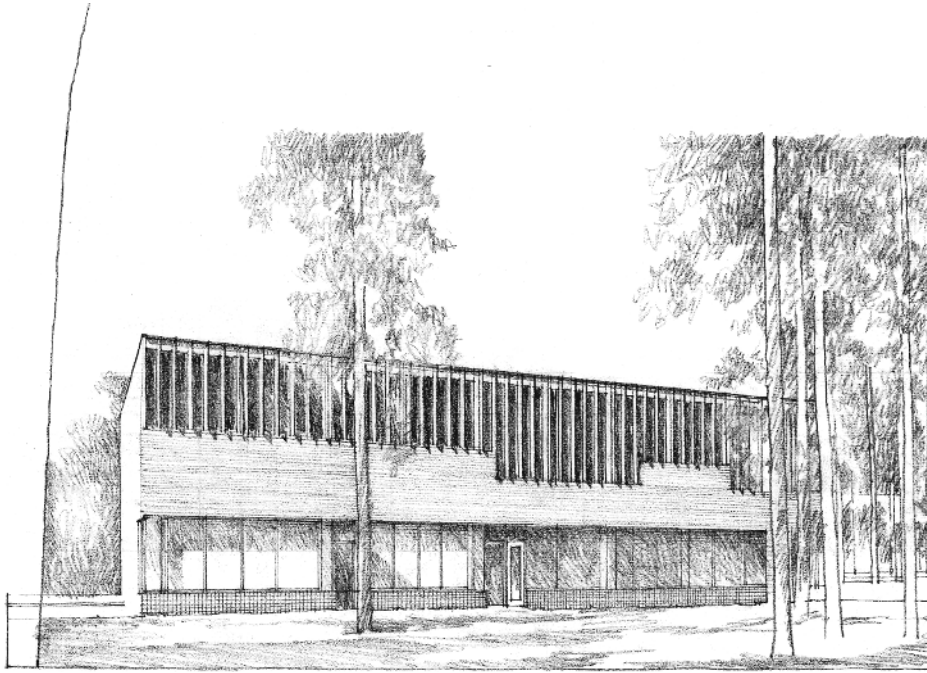

**Town Hall, Säynätsalo**, Finland, 1950–1952, Alvar Aalto

At a smaller scale, lines articulate the edges and surfaces of planes and volumes. These lines can be expressed by joints within or between building materials, by frames around window or door openings, or by a structural grid of columns and beams. How these linear elements affect the texture of a surface will depend on their visual weight, spacing, and direction.

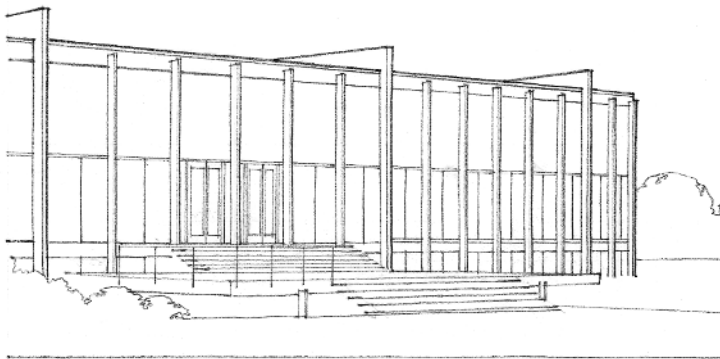

**Crown Hall**, School of Architecture and Urban Design, Illinois Institute of Technology, Chicago, 1956, Mies van der Rohe

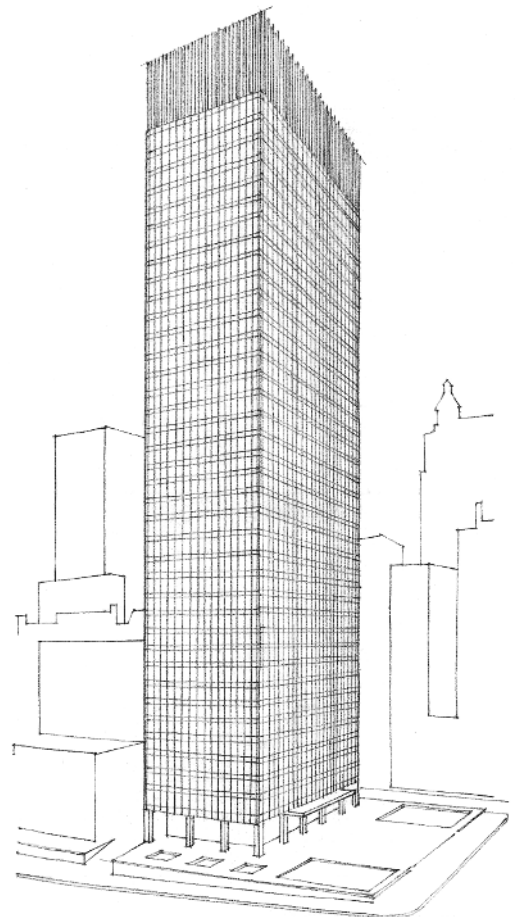

**Seagram Building**, New York City, 1956–1958, Mies van der Rohe and Philip Johnson

# FROM LINE TO PLANE

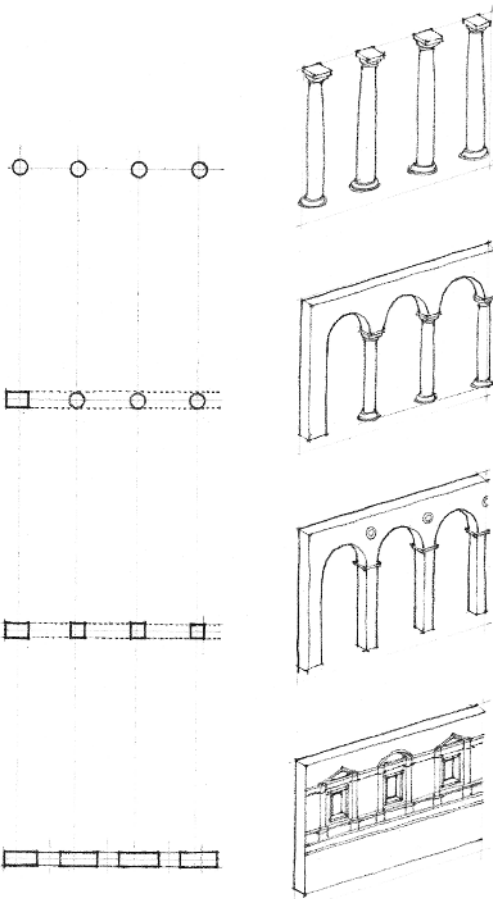
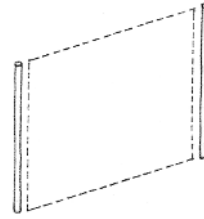
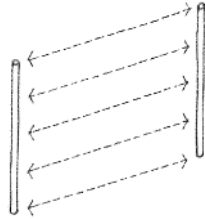
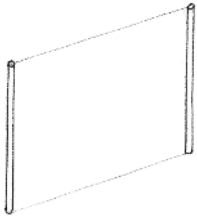

Two parallel lines have the ability to visually describe a plane. A transparent spatial membrane can be stretched between them to acknowledge their visual relationship. The closer these lines are to each other, the stronger will be the sense of plane they convey.

A series of parallel lines, through their repetitiveness, reinforces our perception of the plane they describe. As these lines extend themselves along the plane they describe, the implied plane becomes real and the original voids between the lines revert to being mere interruptions of the planar surface.

The diagrams illustrate the transformation of a row of round columns, initially supporting a portion of a wall, then evolving into square piers which are an integral part of the wall plane, and finally becoming pilasters—remnants of the original columns occurring as a relief along the surface of the wall.

“The column is a certain strengthened part of a wall, carried up perpendicular from the foundation to the top . . . A row of columns is indeed nothing but a wall, open and discontinued in several places.” *Leon Battista Alberti*

## LINEAR ELEMENTS DEFINING PLANES

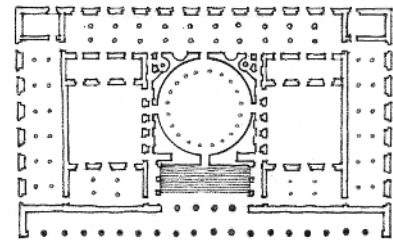
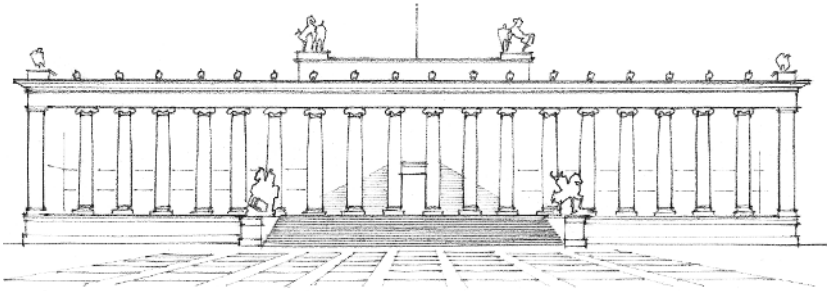

**Altes Museum**, Berlin, 1823–1830, Karl Friedrich Schinkel

A row of columns supporting an entablature—a colonnade—is often used to define the public face or facade of a building, especially one that fronts on a major civic space. A colonnaded facade can be penetrated easily for entry, offers a degree of shelter from the elements, and forms a semi-transparent screen that unifies individual building forms behind it.

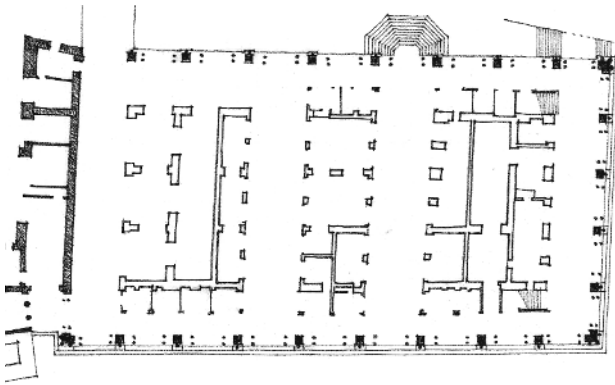
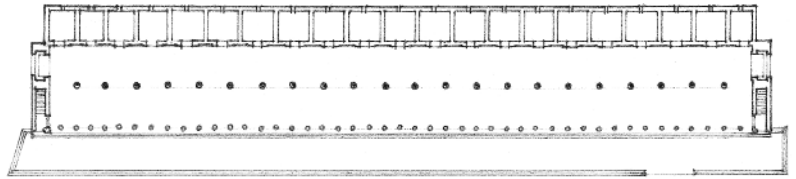

**The Basilica**, Vicenza, Italy.

Andrea Palladio designed this two-story loggia in 1545 to wrap around an existing medieval structure. This addition not only buttressed the existing structure but also acted as a screen that disguised the irregularity of the original core and presented a uniform but elegant face to the Piazza del Signori.

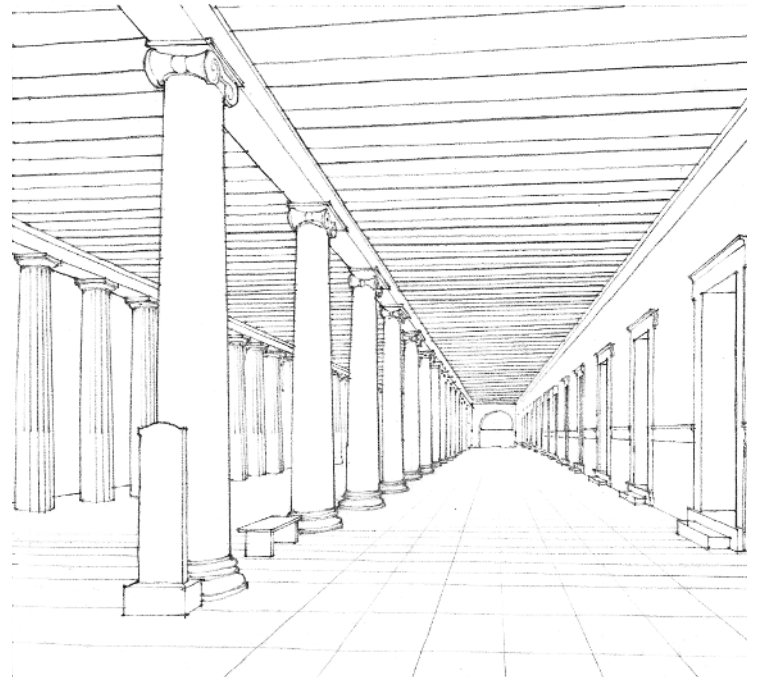

**Stoa of Attalus** fronting the Agora in Athens

# LINEAR ELEMENTS DEFINING PLANES

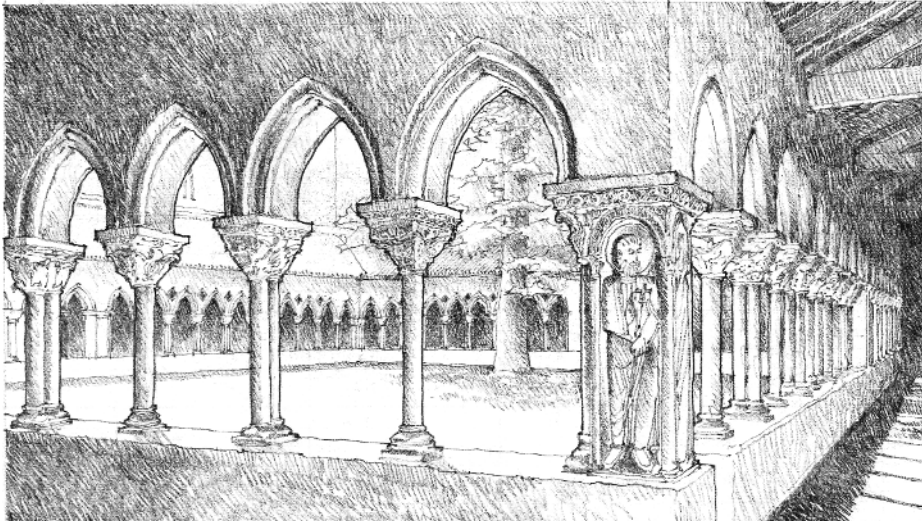

Cloister of **Moissac Abbey**, France, c. 1100

In addition to the structural role columns play in supporting an overhead floor or roof plane, they can articulate the penetrable boundaries of spatial zones that mesh easily with adjacent spaces.

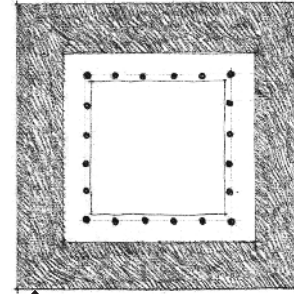

These two examples illustrate how columns can define the edges of an exterior space defined within the mass of a building ..... as well as articulate the edges of a building mass in space .....

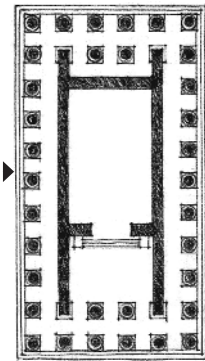

**Temple of Athena Polias**, Priene, c. 334 B.C., Pythius

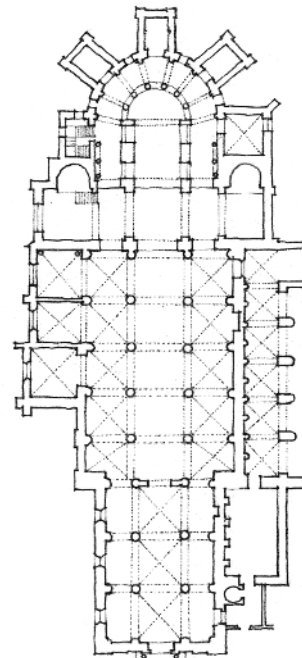
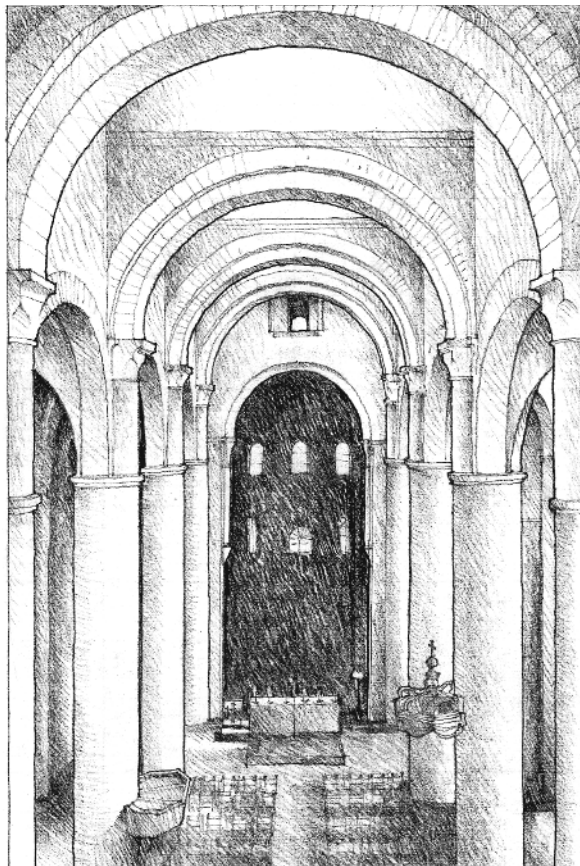

**St. Philibert**, Tournus, France, 950–1120.  
This view of the nave shows how rows of columns can provide a rhythmic measure of space.

## LINEAR ELEMENTS DEFINING PLANES

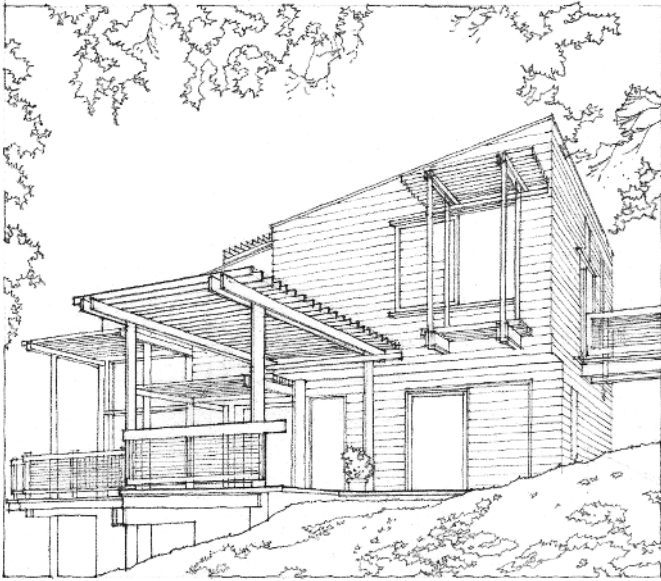

**Cary House**, Mill Valley, California, 1963, Joseph Esherick

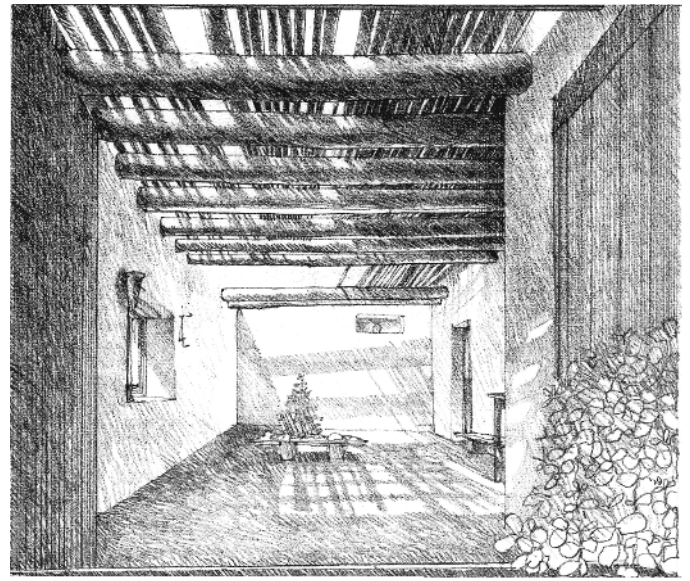

Trellised Courtyard, **Georgia O'Keefe Residence**,  
Abiquiu, northwest of Sante Fe, New Mexico

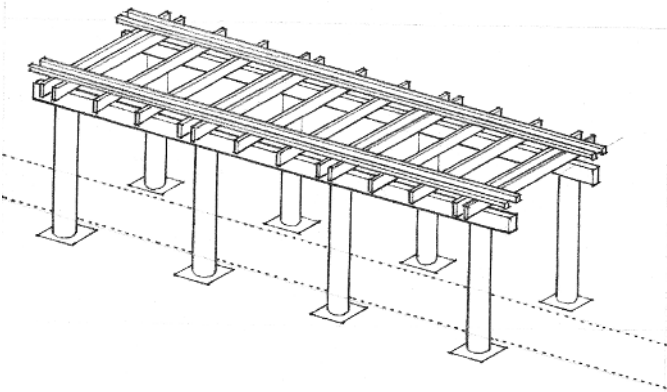

The linear members of trellises and pergolas can provide a moderate degree of definition and enclosure for outdoor spaces while allowing filtered sunlight and breezes to penetrate.

Vertical and horizontal linear elements together can define a volume of space such as the solarium illustrated to the right. Note that the form of the volume is determined solely by the configuration of the linear elements.

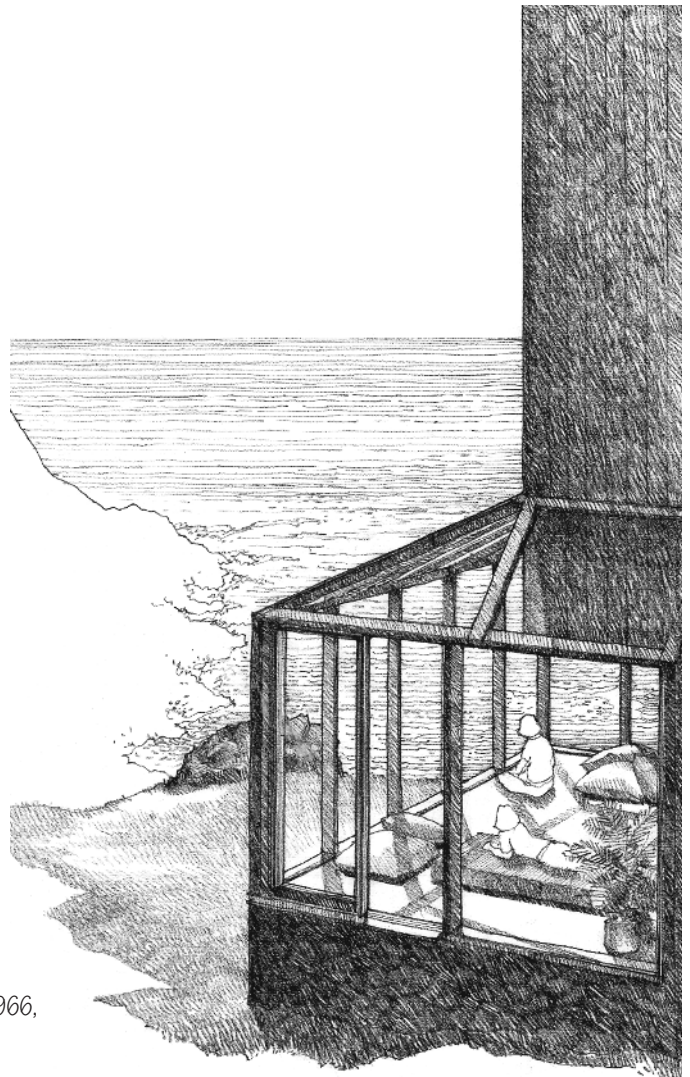

Solarium of **Condominium Unit 1, Sea Ranch**, California, 1966,  
Moore, Lyndon, Turnbull, Whitaker (MLTW)

# PLANE

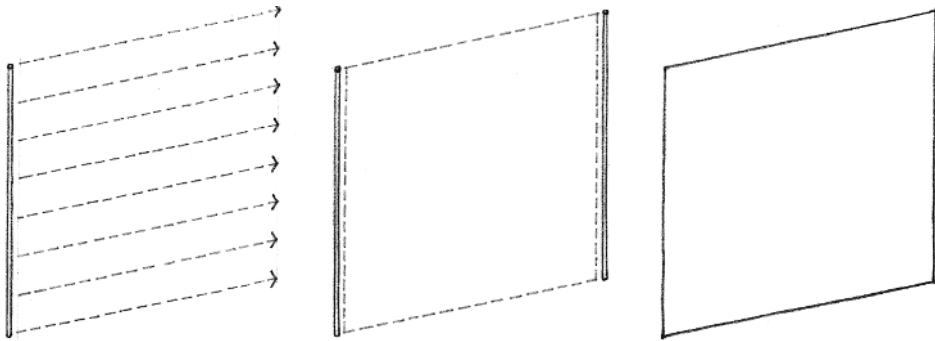

A line extended in a direction other than its intrinsic direction becomes a plane. Conceptually, a plane has length and width, but no depth.

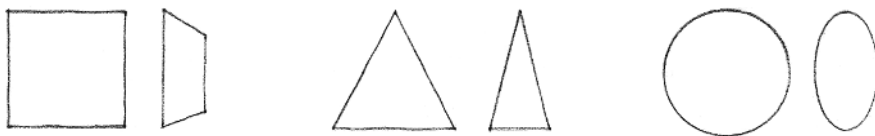

Shape is the primary identifying characteristic of a plane. It is determined by the contour of the line forming the edges of a plane. Because our perception of shape can be distorted by perspective foreshortening, we see the true shape of a plane only when we view it frontally.



The supplementary properties of a plane—its surface color, pattern, and texture—affect its visual weight and stability.

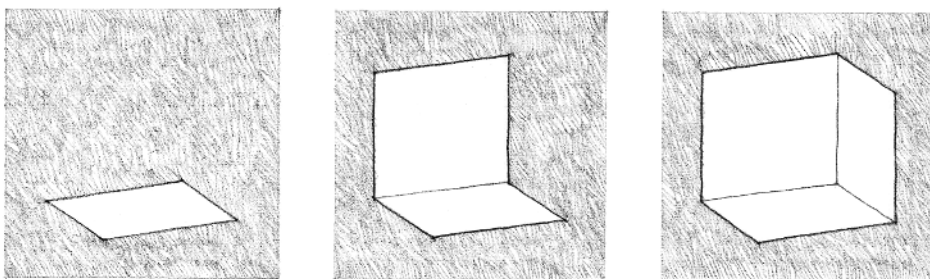

In the composition of a visual construction, a plane serves to define the limits or boundaries of a volume. If architecture as a visual art deals specifically with the formation of three-dimensional volumes of mass and space, then the plane should be regarded as a key element in the vocabulary of architectural design.

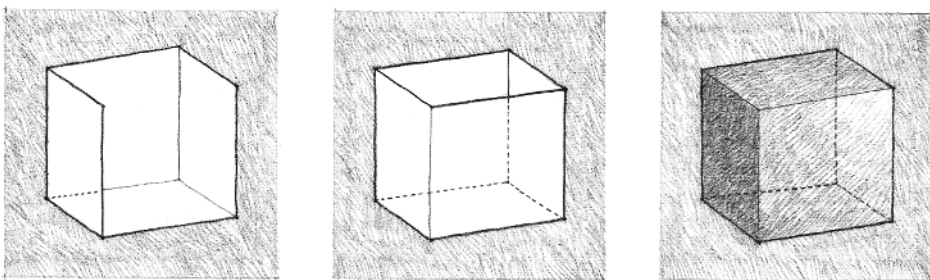

Planes in architecture define three-dimensional volumes of mass and space. The properties of each plane—size, shape, color, texture—as well as their spatial relationship to one another ultimately determine the visual attributes of the form they define and the qualities of the space they enclose.

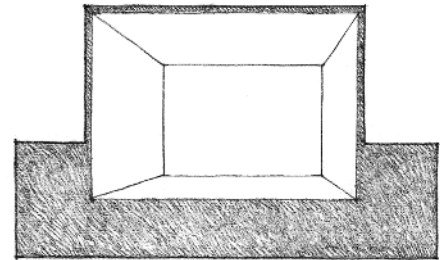
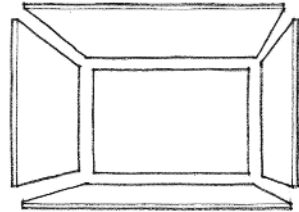
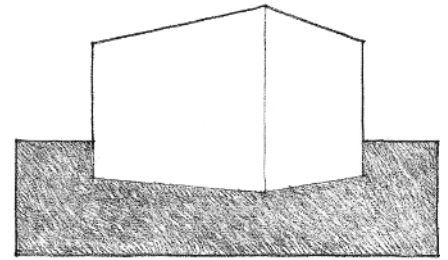
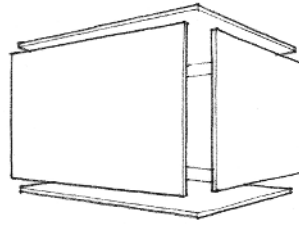

In architectural design, we manipulate three generic types of planes:

**Overhead Plane**

The overhead plane can be either the roof plane that spans and shelters the interior spaces of a building from the climatic elements, or the ceiling plane that forms the upper enclosing surface of a room.

**Wall Plane**

The wall plane, because of its vertical orientation, is active in our normal field of vision and vital to the shaping and enclosure of architectural space.

**Base Plane**

The base plane can be either the ground plane that serves as the physical foundation and visual base for building forms, or the floor plane that forms the lower enclosing surface of a room upon which our physical activities occur.

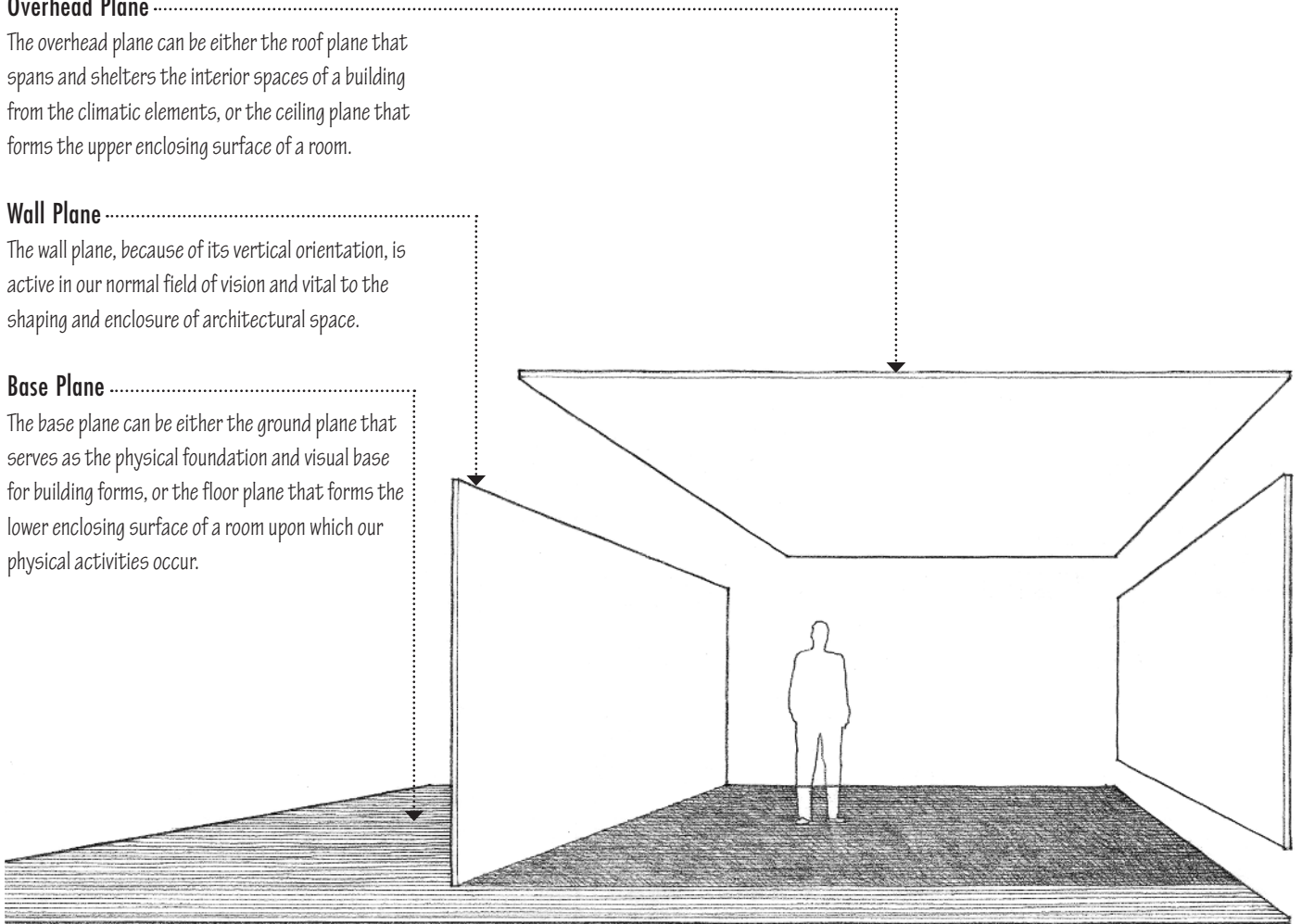

## PLANAR ELEMENTS

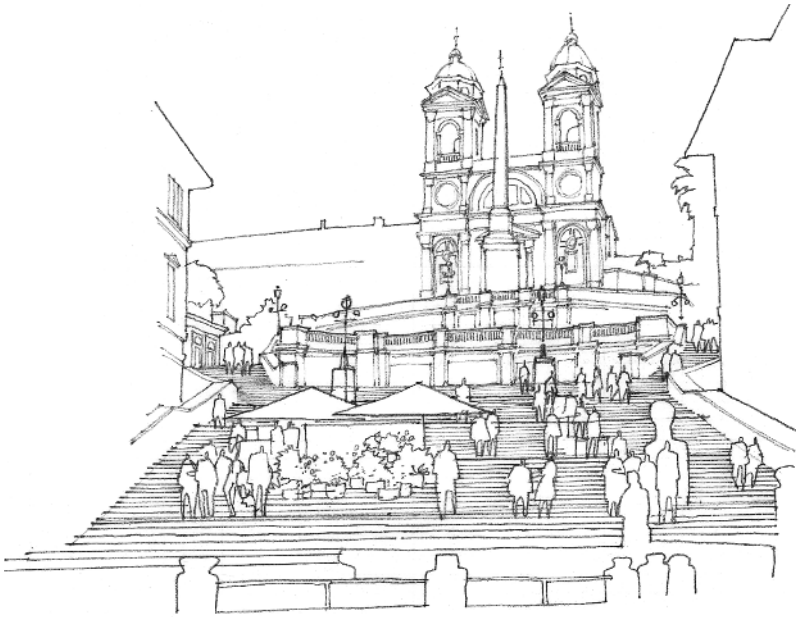

**Scala de Spagna (Spanish Steps),** Rome, 1721–1725.

Alessandro Specchi designed this civic project to connect the Piazza di Spagna with SS. Trinita de' Monti; completed by Francesco de Sanctis.

The ground plane ultimately supports all architectural construction. Along with climate and other environmental conditions of a site, the topographical character of the ground plane influences the form of the building that rises from it. The building can merge with the ground plane, rest firmly on it, or be elevated above it.

The ground plane itself can be manipulated as well to establish a podium for a building form. It can be elevated to honor a sacred or significant place; bermed to define outdoor spaces or buffer against undesirable conditions; carved or terraced to provide a suitable platform on which to build; or stepped to allow changes in elevation to be easily traversed.

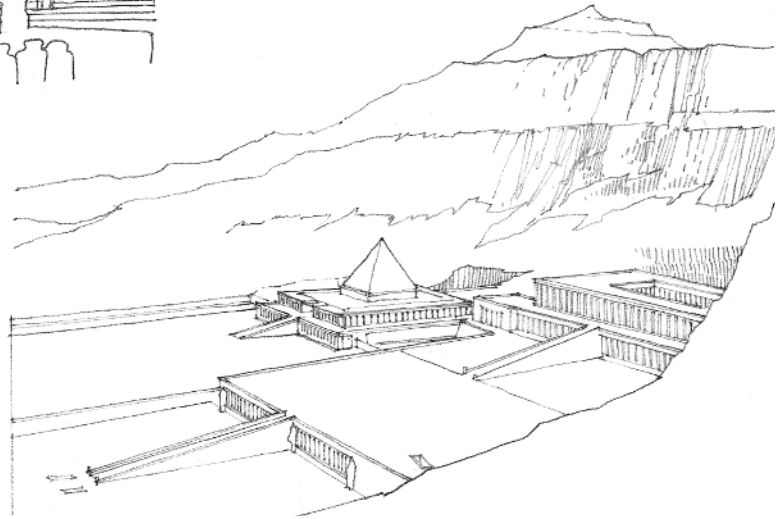

**Mortuary Temple of Queen Hatshepsut,**

Dêr el-Bahari, Thebes, 1511–1480 B.C., Senmut.

Three terraces, approached by ramps, rise toward the base of the cliffs where the chief sanctuary is cut deep into the rock.



**Machu Picchu,** an ancient Incan city established c. 1500 in the Andes Mountains on a saddle between two peaks, 8000 ft. above the Urubamba River in south-central Peru.

Sitting Area, **Lawrence House**,  
Sea Ranch, California, 1966, MLTW

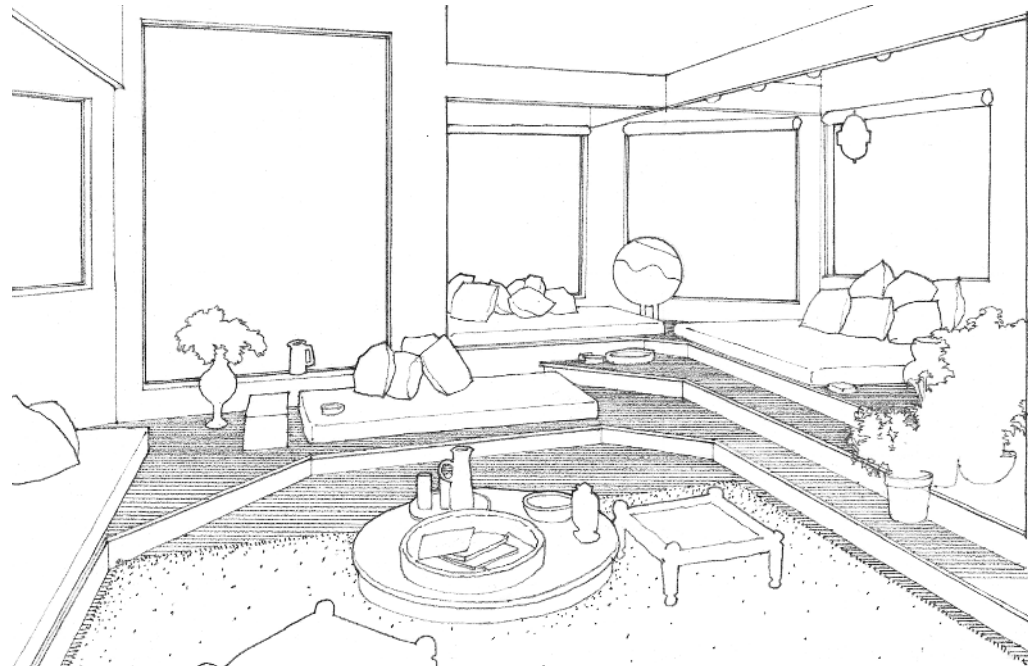

The floor plane is the horizontal element that sustains the force of gravity as we move around and place objects for our use on it. It may be a durable covering of the ground plane or a more artificial, elevated plane spanning the space between its supports. In either case, the texture and density of the flooring material influences both the acoustical quality of a space and how we feel as we walk across its surface.

While the pragmatic, supportive nature of the floor plane limits the extent to which it can be manipulated, it is nonetheless an important element of architectural design. Its shape, color, and pattern determine to what degree it defines spatial boundaries or serves as a unifying element for the different parts of a space.

Like the ground plane, the form of a floor plane can be stepped or terraced to break the scale of a space down to human dimensions and create platforms for sitting, viewing, or performing. It can be elevated to define a sacred or honorific place. It can be rendered as a neutral ground against which other elements in a space are seen as figures.

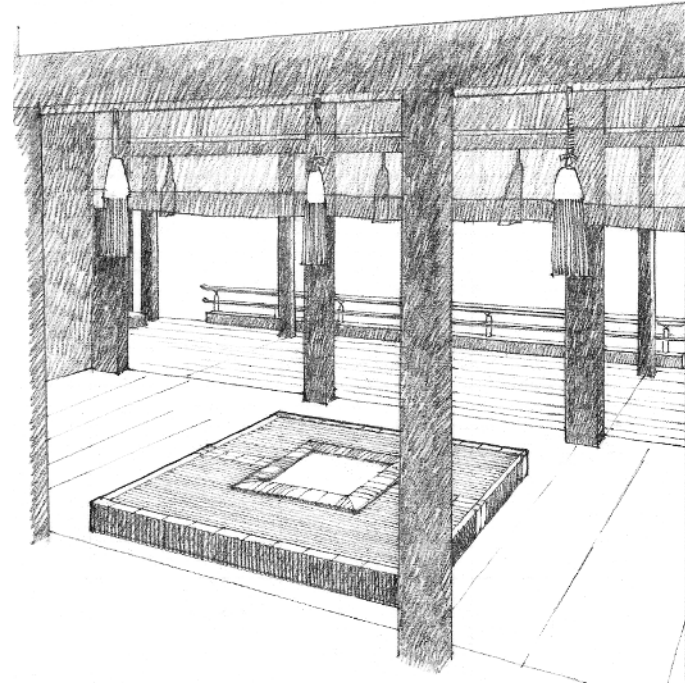

**Emperor's Seat, Imperial Palace**, Kyoto, Japan, 17th century

**Bacardi Office Building**  
(Project), Santiago de Cuba,  
1958, Mies van der Rohe

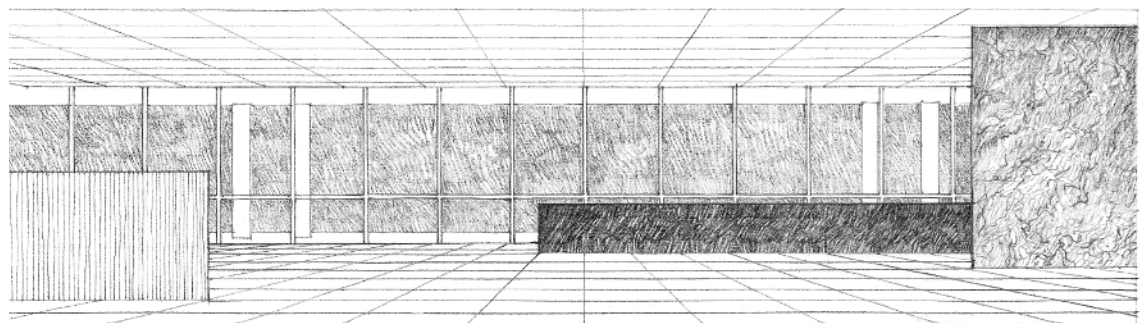

## PLANAR ELEMENTS



**S. Maria Novella**, Florence, 1456–1470.

The Renaissance facade by Alberti presents a public face to a square.

Exterior wall planes isolate a portion of space to create a controlled interior environment. Their construction provides both privacy and protection from the climatic elements for the interior spaces of a building, while openings within or between their boundaries reestablish a connection with the exterior environment. As exterior walls mold interior space, they simultaneously shape exterior space and describe the form, massing, and image of a building in space.

As a design element, the plane of an exterior wall can be articulated as the front or primary facade of a building. In urban situations, these facades serve as walls that define courtyards, streets, and such public gathering places as squares and marketplaces.



**Uffizi Palace**, 1560–1565, Giorgio Vasari.

This Florentine street defined by the two wings of the Uffizi Palace links the Piazza della Signoria with the River Arno.

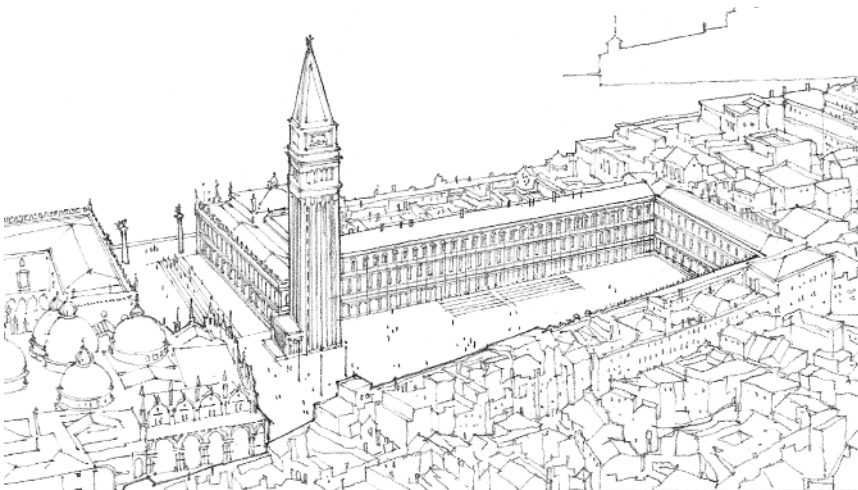

**Piazza San Marco**, Venice.

The continuous facades of buildings form the "walls" of the urban space.

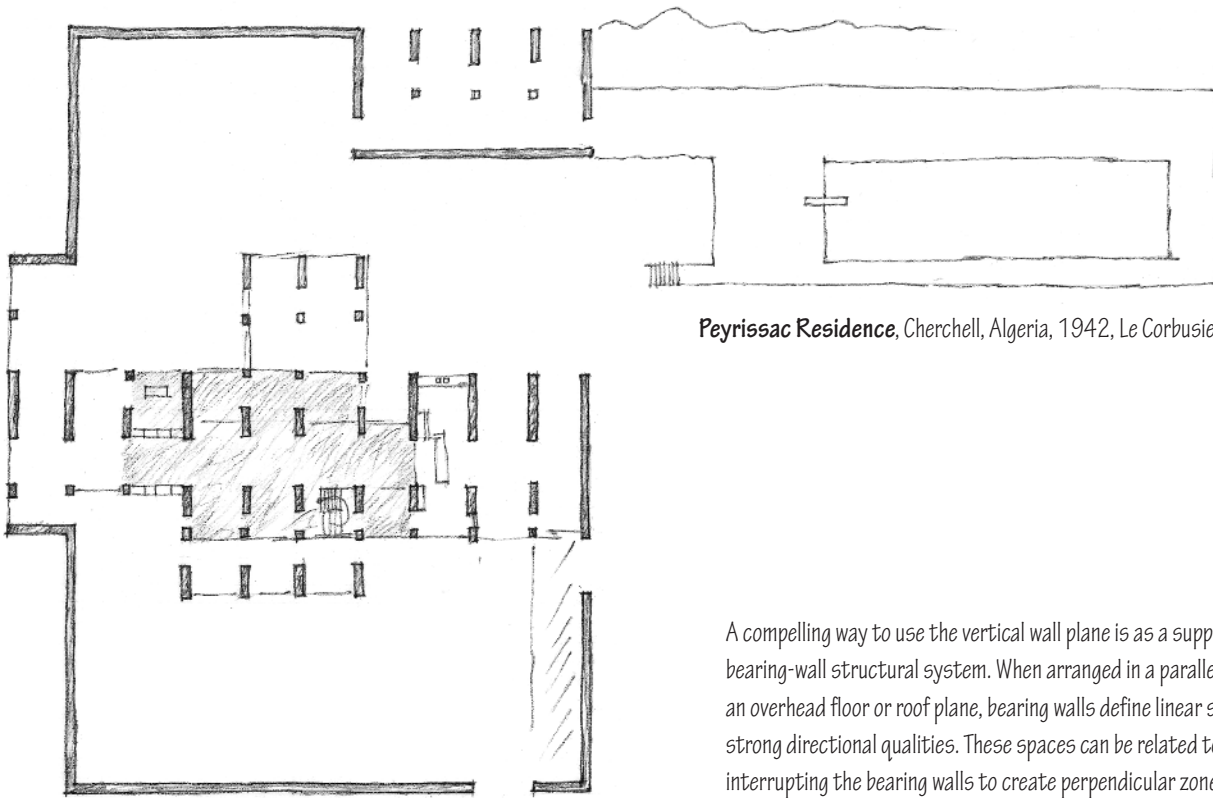

**Peyrissac Residence**, Cherchell, Algeria, 1942, Le Corbusier

A compelling way to use the vertical wall plane is as a supporting element in the bearing-wall structural system. When arranged in a parallel series to support an overhead floor or roof plane, bearing walls define linear slots of space with strong directional qualities. These spaces can be related to one another only by interrupting the bearing walls to create perpendicular zones of space.

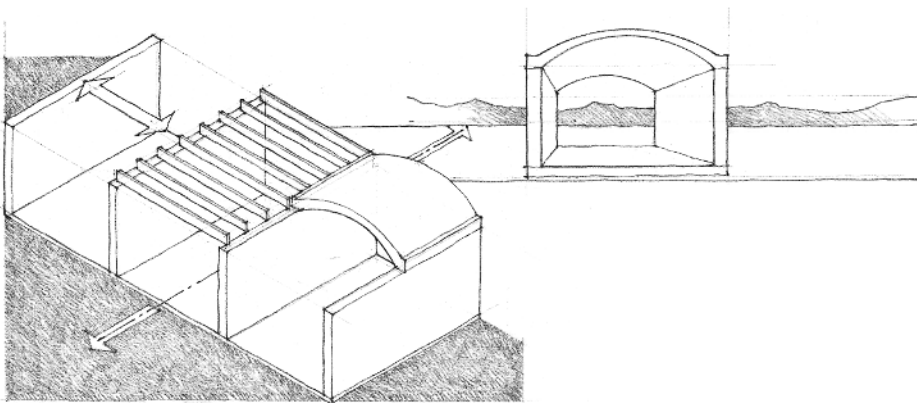

**Country House in Brick** (Project), 1923, Mies van der Rohe

In the project to the right, freestanding brick bearing walls, together with L-shaped and T-shaped configurations of planes, create an interlocking series of spaces.



## PLANAR ELEMENTS

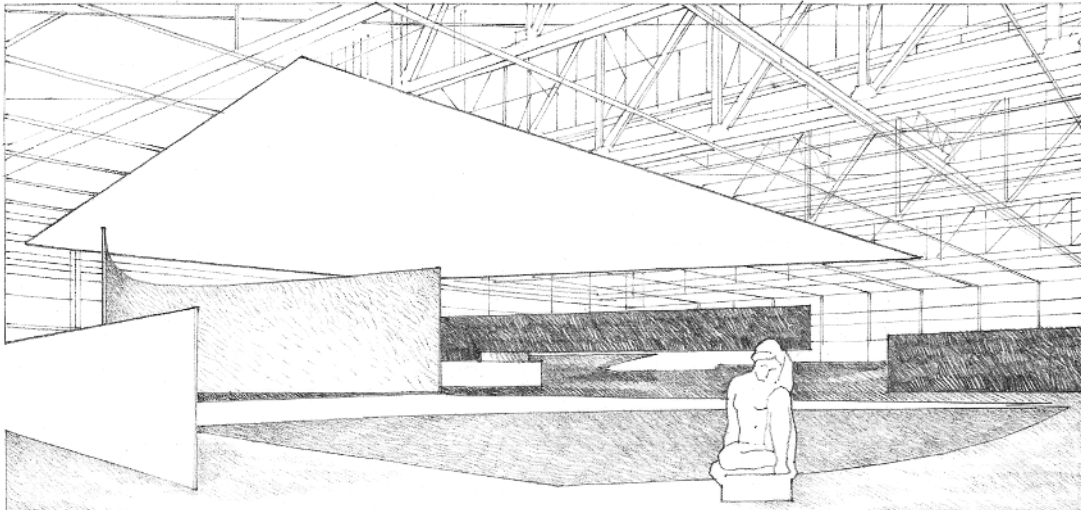

**Concert Hall** (Project), 1942,  
Mies van der Rohe

Interior wall planes govern the size and shape of the internal spaces or rooms within a building. Their visual properties, their relationship to one another, and the size and distribution of openings within their boundaries determine both the quality of the spaces they define and the degree to which adjoining spaces relate to one another.

As a design element, a wall plane can merge with the floor or ceiling plane, or be articulated as an element isolated from adjacent planes. It can be treated as a passive or receding backdrop for other elements in the space, or it can assert itself as a visually active element within a room by virtue of its form, color, texture, or material.

While walls provide privacy for interior spaces and serve as barriers that limit our movement, doorways and windows reestablish continuity with neighboring spaces and allow the passage of light, heat, and sound. As they increase in size, these openings begin to erode the natural sense of enclosure walls provide. Views seen through the openings become part of the spatial experience.

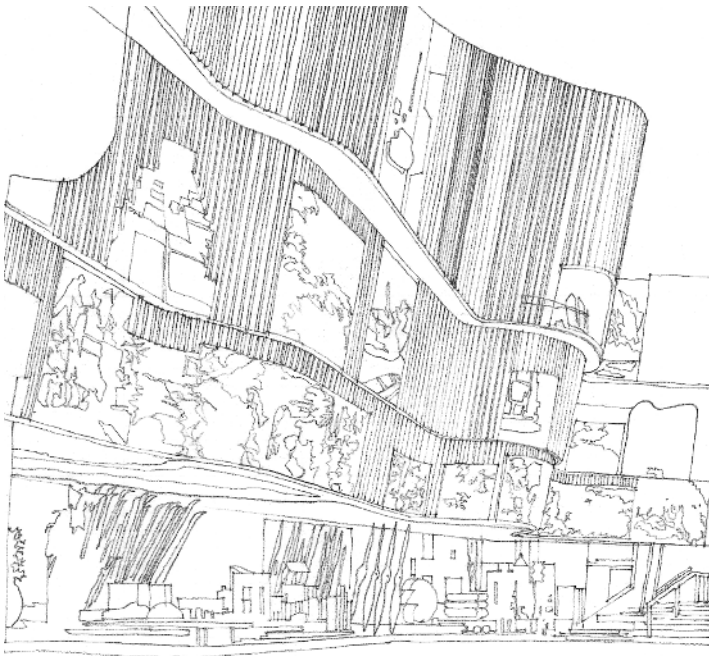

**Finnish Pavilion**, New York World's Fair, 1939, Alvar Aalto

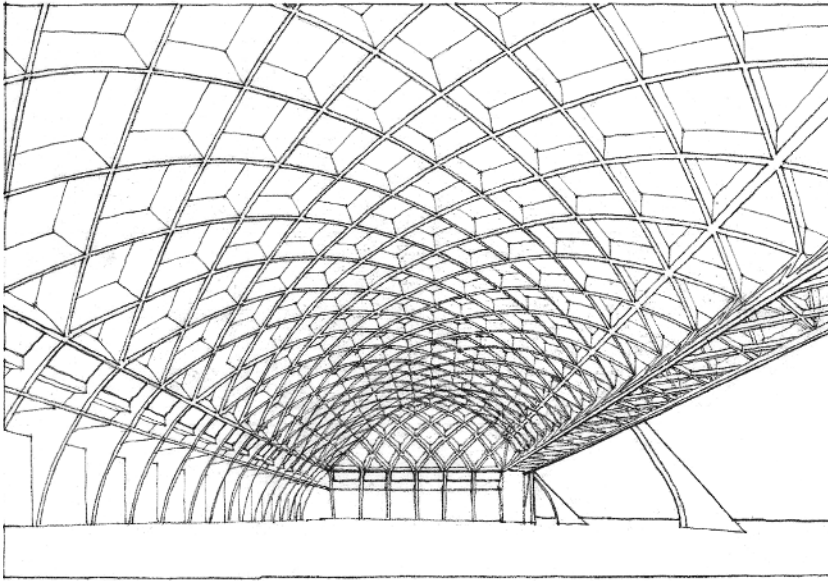

**Hangar, Design I**, 1935, Pier Luigi Nervi.

The lamella structure expresses the way forces are resolved and channeled down to the roof supports.

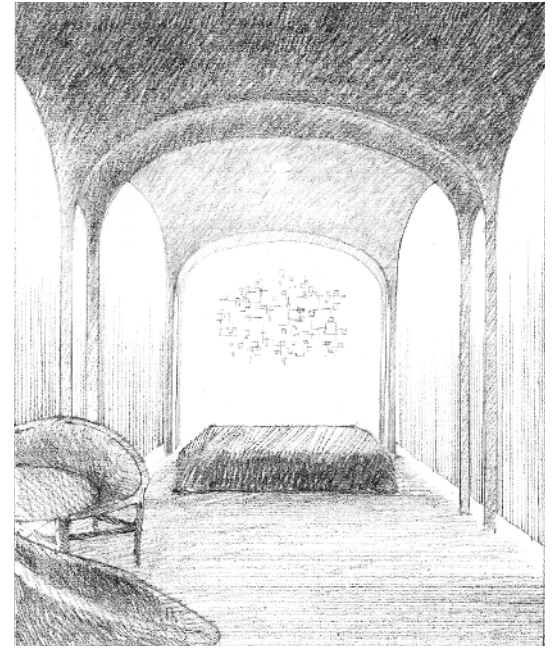

**Brick House**, New Canaan, Connecticut, 1949, Philip Johnson. The detached vaulted ceiling plane appears to float above the bed.

While we walk on a floor and have physical contact with walls, the ceiling plane is usually out of our reach and is almost always a purely visual event in a space. It may be the underside of an overhead floor or roof plane and express the form of its structure as it spans the space between its supports, or it may be suspended as the upper enclosing surface of a room or hall.

As a detached lining, the ceiling plane can symbolize the sky vault or be the primary sheltering element that unifies the different parts of a space. It can serve as a repository for frescoes and other means of artistic expression or be treated simply as a passive or receding surface. It can be raised or lowered to alter the scale of a space or to define spatial zones within a room. Its form can be manipulated to control the quality of light or sound within a space.

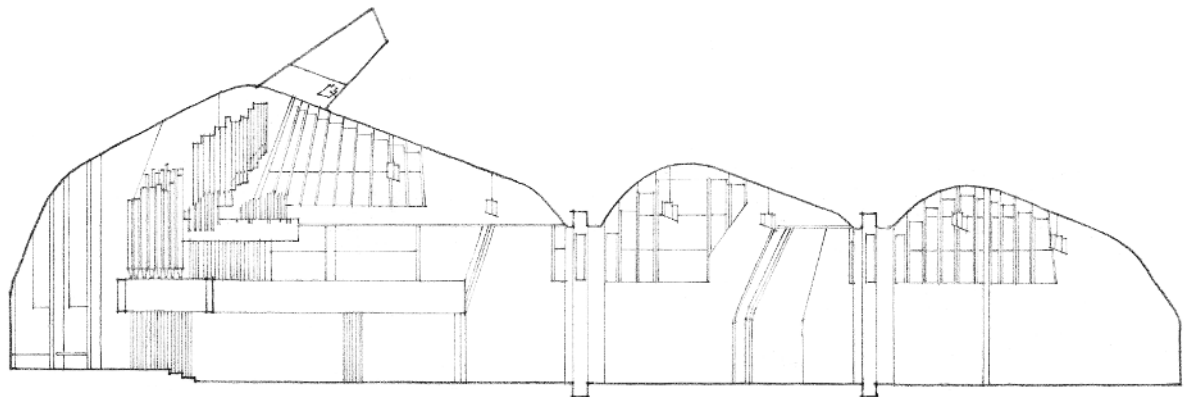

**Church at Vuoksenniska**, Imatra, Finland, 1956, Alvar Aalto.

The form of the ceiling plane defines a progression of spaces and enhances their acoustical quality.

## PLANAR ELEMENTS



**Dolmen**, a prehistoric monument consisting of two or more large upright stones supporting a horizontal stone slab, found especially in Britain and France and usually regarded as a burial place for an important person.

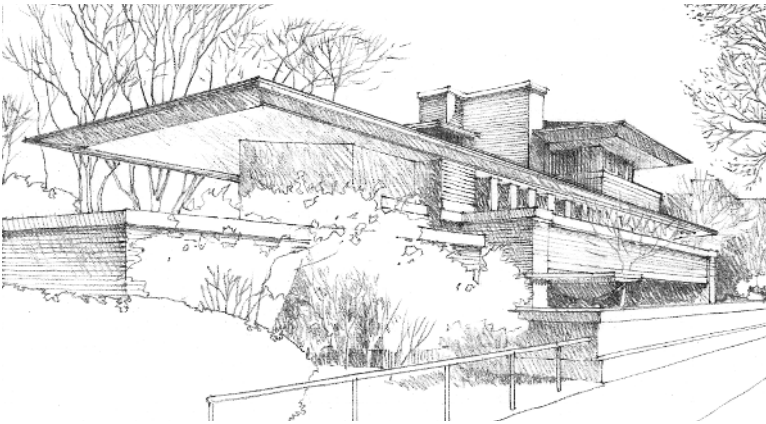

**Robie House**, Chicago, 1909, Frank Lloyd Wright.

The low sloping roof planes and broad overhangs are characteristic of the Prairie School of Architecture.

**Shodhan House**, Ahmedabad, India, 1956, Le Corbusier.

A grid of columns elevates the reinforced concrete roof slab above the main volume of the house.

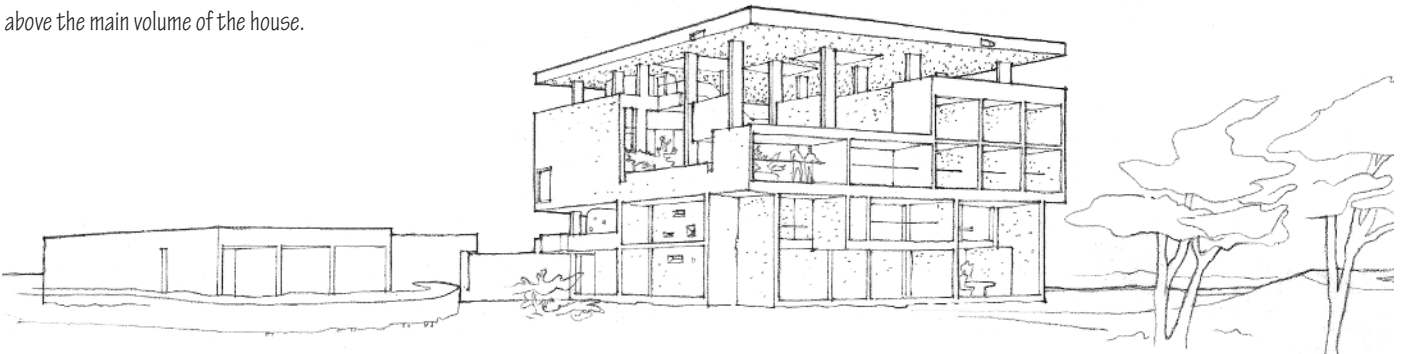

The roof plane is the essential sheltering element that protects the interior of a building from the climatic elements. The form and geometry of its structure is established by the manner in which it spans across space to bear on its supports and slopes to shed rain and melting snow. As a design element, the roof plane is significant because of the impact it can have on the form and silhouette of a building within its setting.

The roof plane can be hidden from view by the exterior walls of a building or merge with the walls to emphasize the volume of the building mass. It can be expressed as a single sheltering form that encompasses a variety of spaces beneath its canopy, or comprise a number of hats that articulate a series of spaces within a single building.

A roof plane can extend outward to form overhangs that shield door and window openings from sun or rain, or continue downward further still to relate itself more closely to the ground plane. In warm climates, it can be elevated to allow cooling breezes to flow across and through the interior spaces of a building.

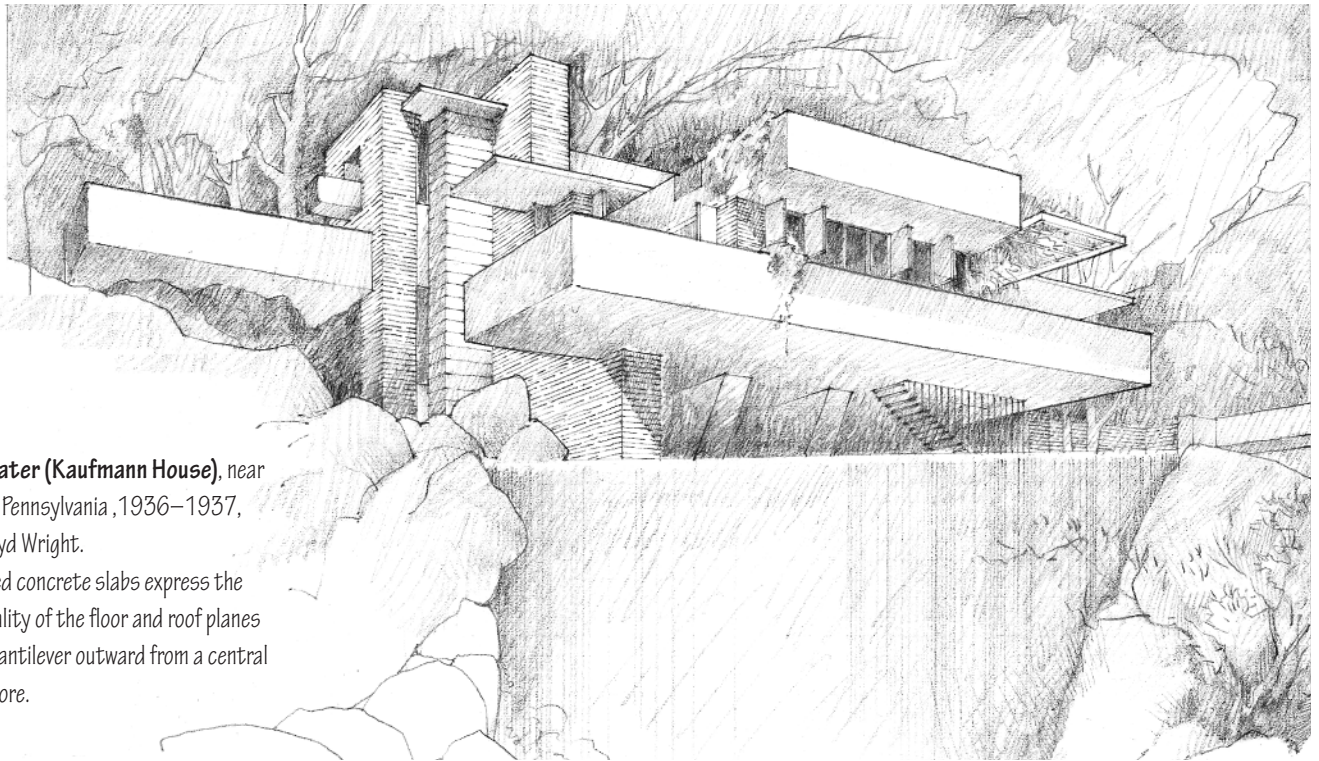

**Fallingwater (Kaufmann House)**, near Ohiopyle, Pennsylvania, 1936–1937, Frank Lloyd Wright.  
Reinforced concrete slabs express the horizontality of the floor and roof planes as they cantilever outward from a central vertical core.

The overall form of a building can be endowed with a distinctly planar quality by carefully introducing openings that expose the edges of vertical and horizontal planes. These planes can be further differentiated and accentuated by changes in color, texture, or material.

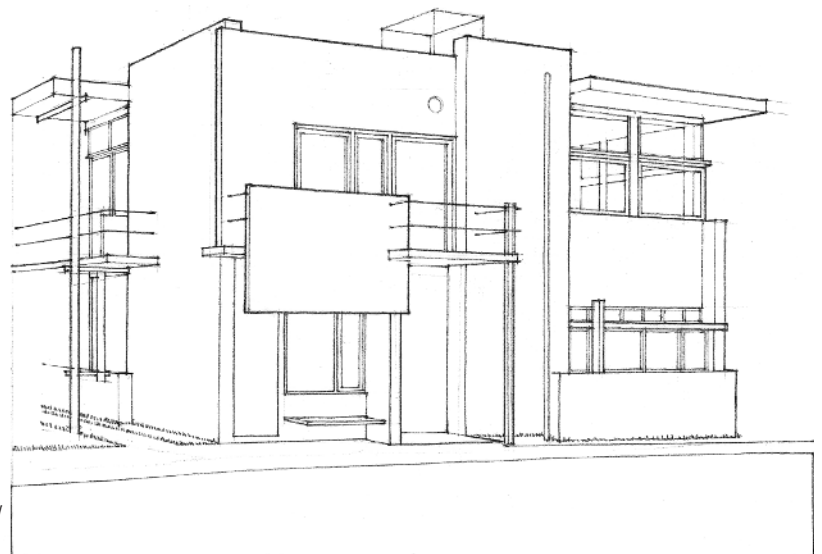

**Schröder House**, Utrecht, 1924–1925, Gerrit Thomas Rietveld.  
Asymmetrical compositions of simple rectangular forms and primary colors characterized the de Stijl School of Art and Architecture.

# VOLUME

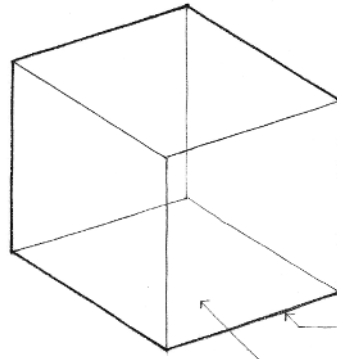
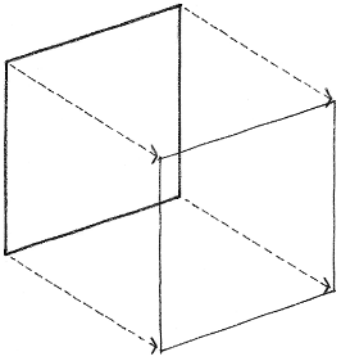

A plane extended in a direction other than its intrinsic direction becomes a volume. Conceptually, a volume has three dimensions: length, width, and depth.

All volumes can be analyzed and understood to consist of:

- points or vertices where several planes come together
- lines or edges where two planes meet
- planes or surfaces that define the limits or boundaries of a volume

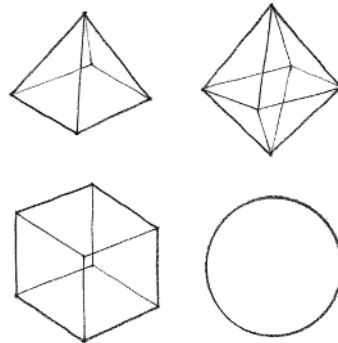

Form is the primary identifying characteristic of a volume. It is established by the shapes and interrelationships of the planes that describe the boundaries of the volume.

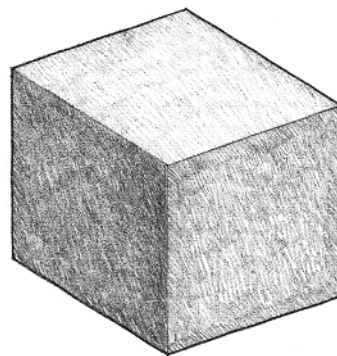
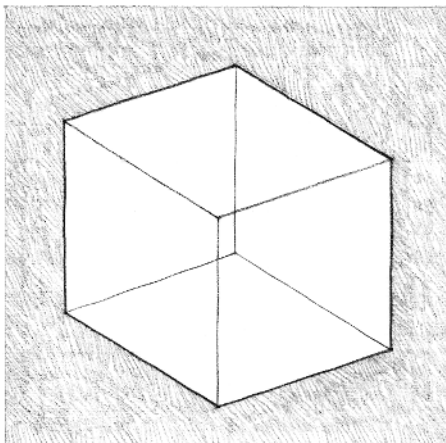

As the three-dimensional element in the vocabulary of architectural design, a volume can be either a solid—space displaced by mass—or a void—space contained or enclosed by planes.

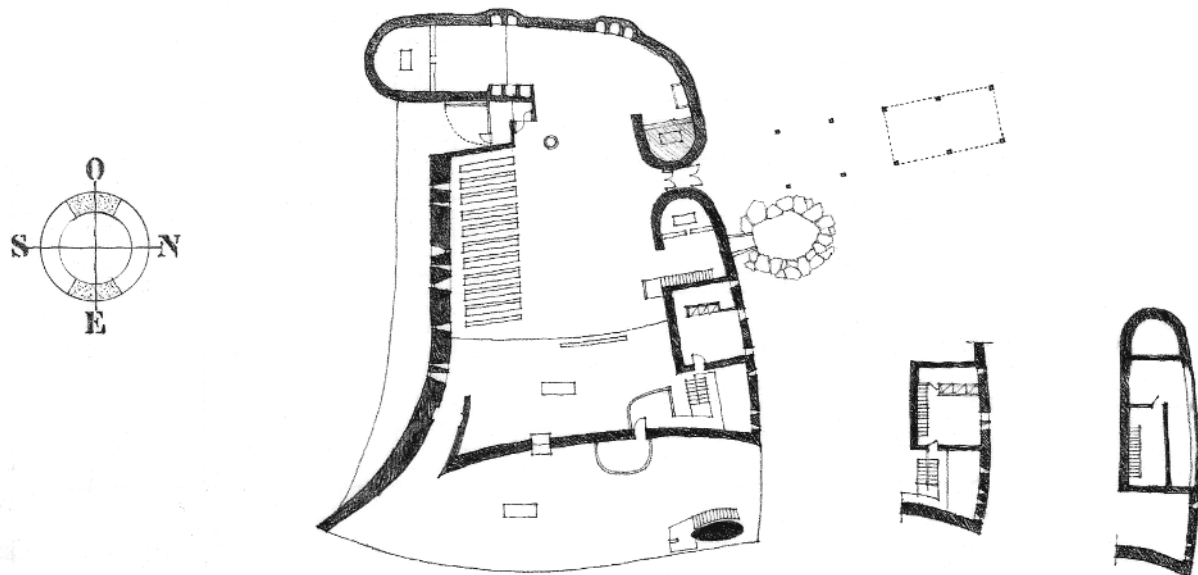

**Plan and Section**

Space defined by wall, floor, and ceiling or roof planes

In architecture, a volume can be seen to be either a portion of space contained and defined by wall, floor, and ceiling or roof planes, or a quantity of space displaced by the mass of a building. It is important to perceive this duality, especially when reading orthographic plans, elevations, and sections.

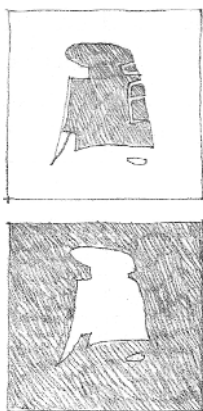

**Elevation**

Space displaced by the mass of a building

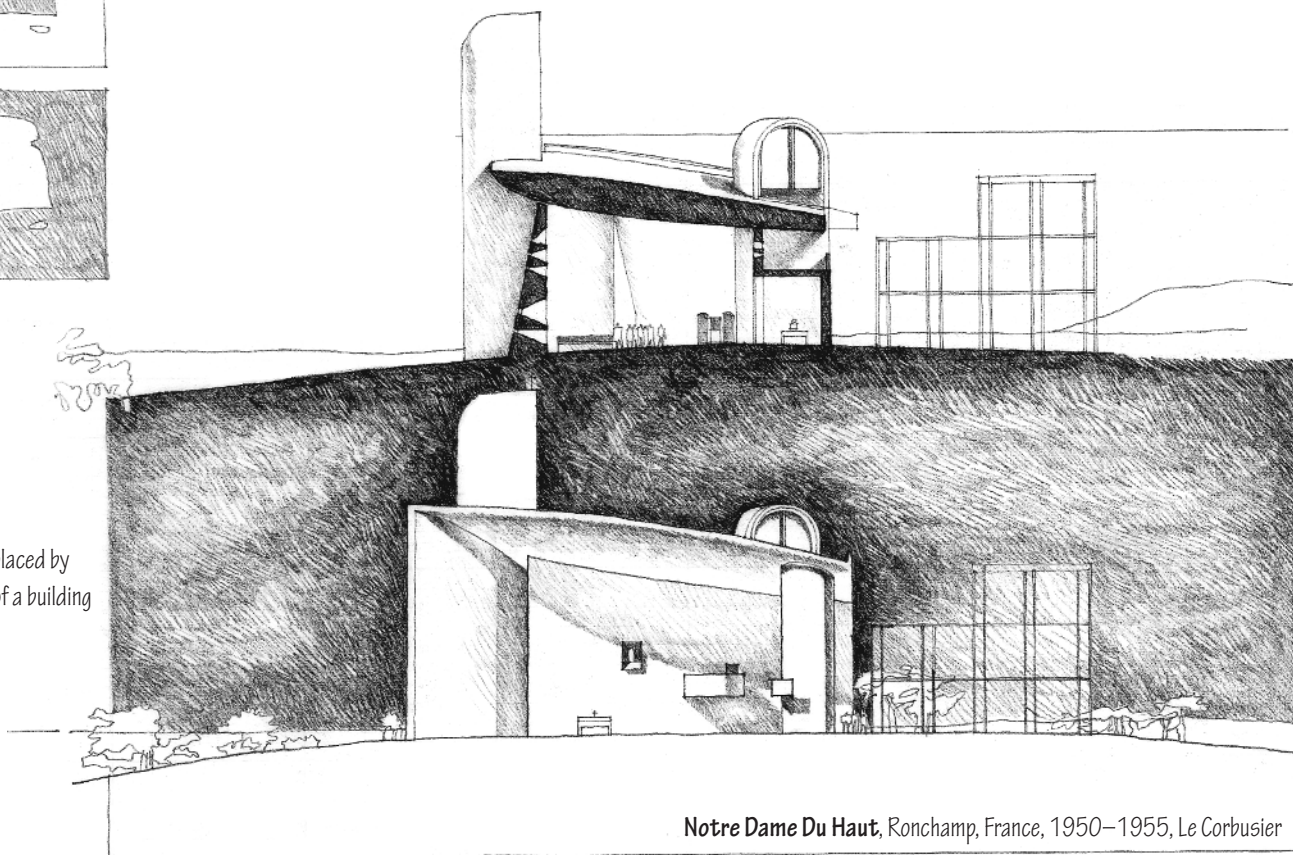

Notre Dame Du Haut, Ronchamp, France, 1950–1955, Le Corbusier

## VOLUMETRIC ELEMENTS

Building forms that stand as objects in the landscape can be read as occupying volumes in space.

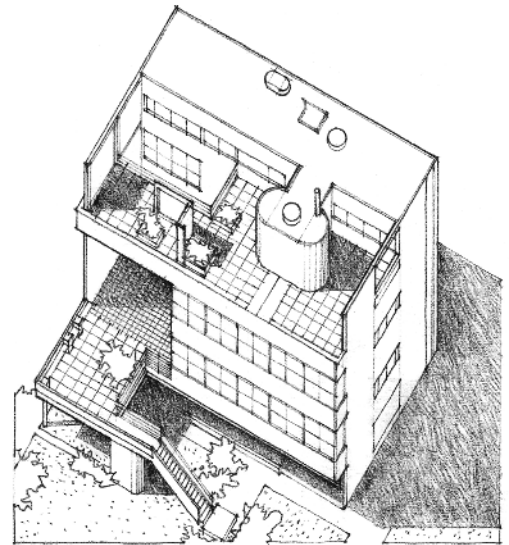

**Doric Temple at Segesta**, Sicily, c. 424–416 B.C.



**Villa Garches**, Vaucresson, France, 1926–1927,  
Le Corbusier

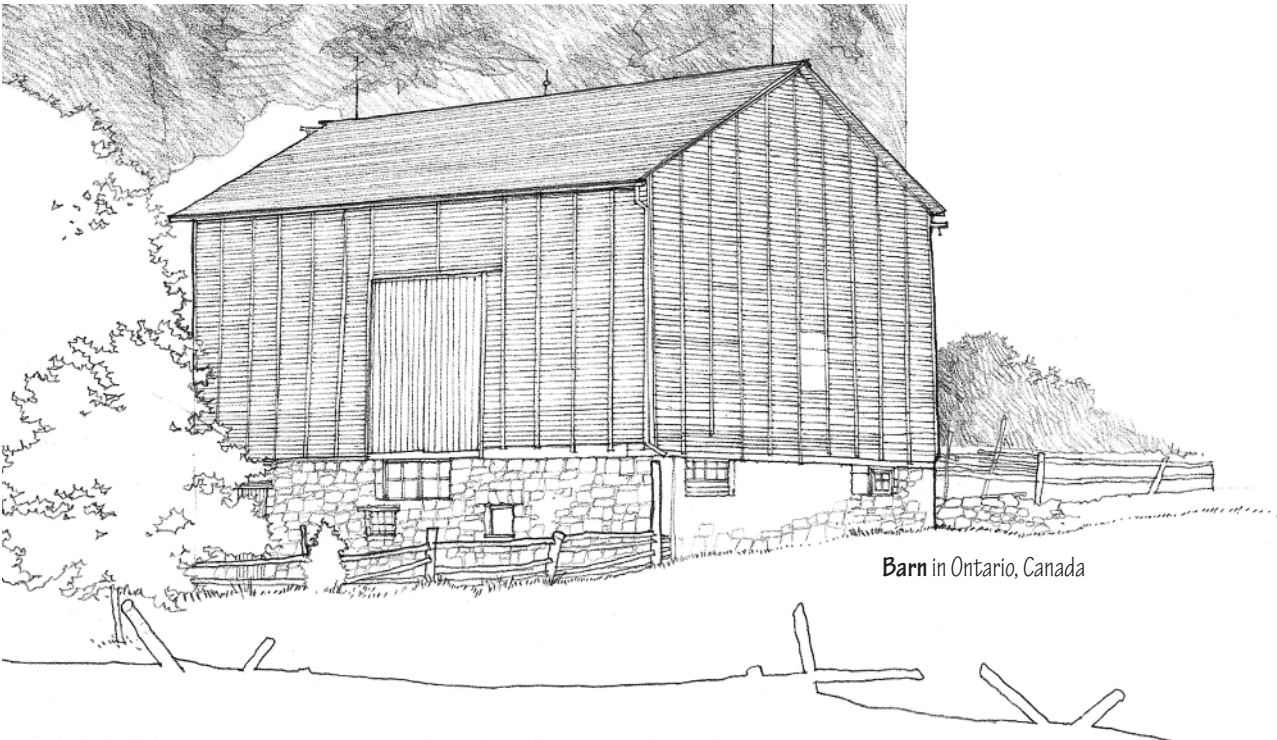

**Barn** in Ontario, Canada

## VOLUMETRIC ELEMENTS

Building forms that serve as containers can be read as masses that define volumes of space.

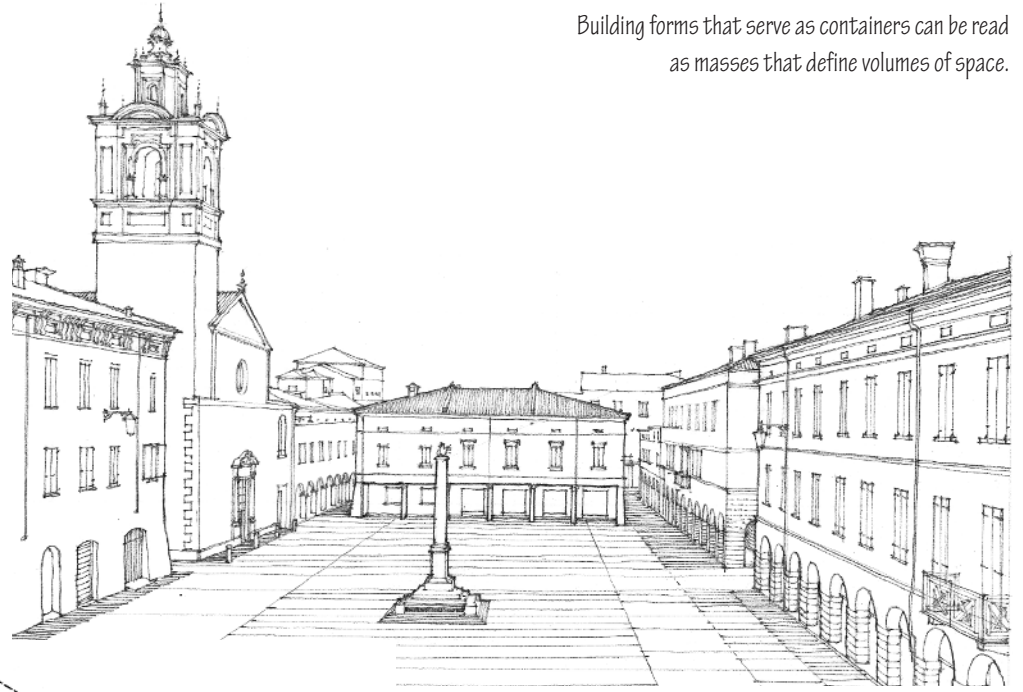

**Piazza Maggiore**, Sabbioneta, Italy.  
A series of buildings enclose an urban square.

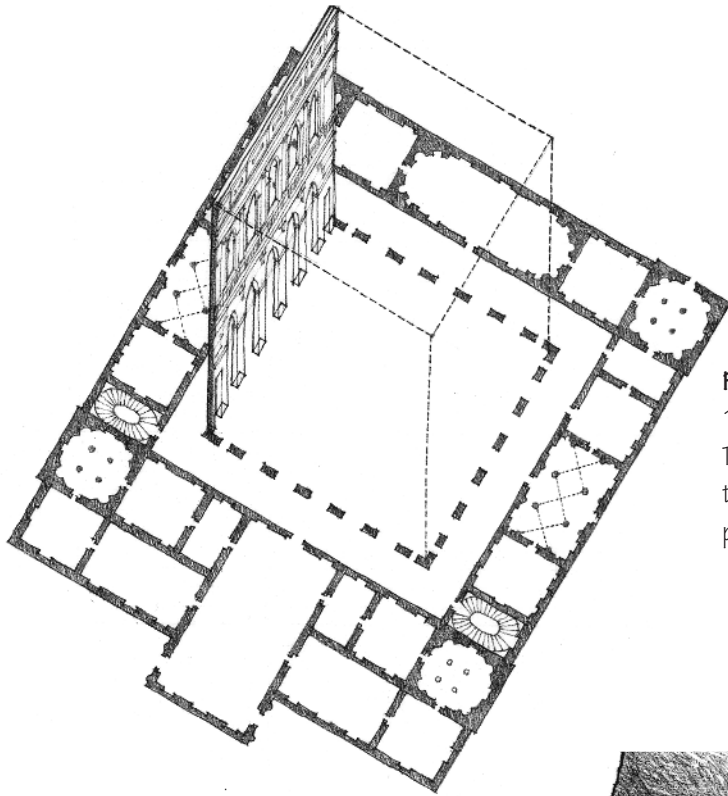

**Palazzo Thiene**, Vicenza, Italy,  
1545, Andrea Palladio.  
The interior rooms surround a cortile—  
the principal courtyard of an Italian  
palazzo.

**Buddhist Chaitya Hall at Karli**,  
Maharashtra, India, A.D. 100–125.  
The sanctuary is a volume of space carved  
out of the mass of solid rock.

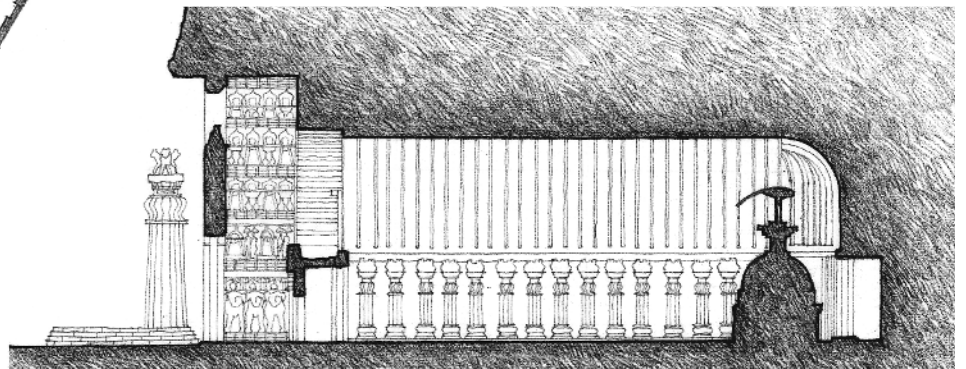

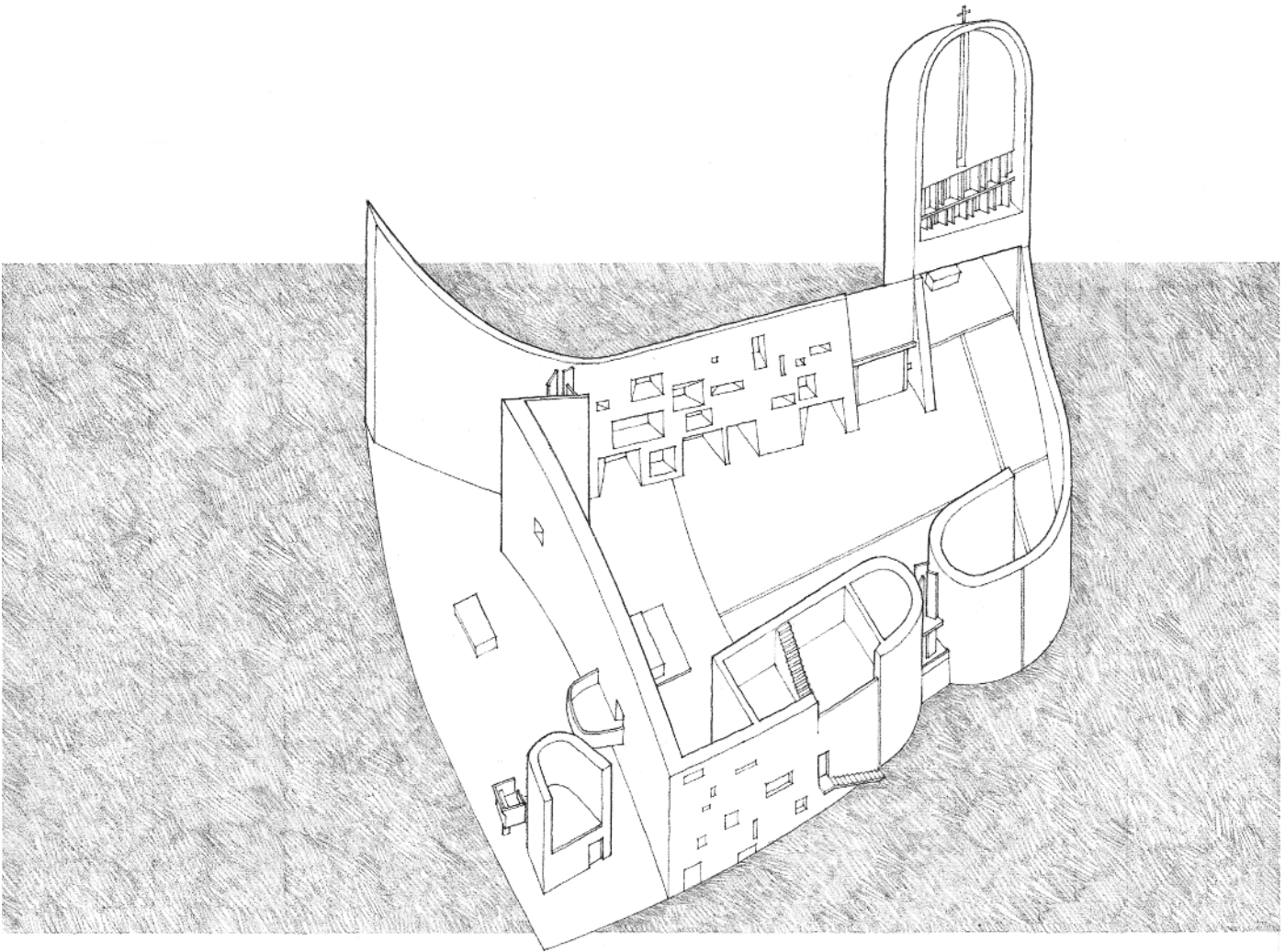

**Notre Dame Du Haut**, Ronchamp, France, 1950–1955, Le Corbusier